

Efficiency of the Installation to Treatment of Outflow from the Hybrid Constructed Wetland System and Possibility of Reuse of Treated Wastewater in the Household

Anna Myka-Raduj^{1,2}, Tadeusz Siwiec², Kamila Rybczyńska-Tkaczyk³, Waldemar Raduj¹, Krzysztof Józwiakowski^{2*}

¹ Polesie National Park, ul. Lubelska 3a, 22-234 Urszulin, Poland;

² Department of Environmental Engineering and Geodesy, University of Life Sciences in Lublin, ul. Leszczyńskiego 7, 20-069 Lublin, Poland

³ Department of Environmental Microbiology, Faculty of Agrobioengineering, University of Life Sciences in Lublin, ul. Leszczyńskiego 7, 20-069 Lublin, Poland

* Corresponding author's e-mail: krzysztof.jozwiakowski@up.lublin.pl

ABSTRACT

The purpose of this study was to determine the effectiveness of the operation of a novel installation for treating the outflow from a hybrid constructed wetland system and the possibility of domestic wastewater reuse. The study was carried out in 2022–2023 at a facility located in the Polesie National Park (PNP) in Poland. The analyzed installation for the treatment of wastewater discharged from the constructed wetland system is located in the basement of a single-family building and consists of a filtration system including: yarn, spun and carbon filters, and a UV lamp. In turn, the hybrid constructed wetland system from which the treated wastewater is recycled to the building consists of a 2-chamber primary settling tank and a system of two VF-HF type beds with common reed and willow. During the study period (October 2022 to December 2023), 14 series of analyses were performed, during which the values of selected physico-chemical and microbiological indicators were determined in the collected samples of treated wastewater. On the basis of the performed tests, it was found that the analyzed system provided an average efficiency of reduction of total suspended solids and BOD₅ at 46.8 and 45.8%, respectively. Smaller effects were obtained for the reduction of COD (22.7%), total nitrogen (4.9%) and total phosphorus (16.3%). In contrast, the average reduction effects of microbiological indicators were very high, amounting to 92.7 and 97.1% for *Escherichia coli* and enterococcus bacteria, respectively. The study showed that the effluent flowing out of the hybrid constructed wetland system after treatment in the analyzed installation could be reused for toilet flushing or green watering, as it usually did not contain microbiological contaminants. It was determined that the recycled treated wastewater could replace, on average, 18.7% of the good-quality water supplied by the mains water supply in the studied household.

Keywords: closed water circuit; hybrid constructed wetland system; pollution removal; water management; water protection, Polesie National Park.

INTRODUCTION

The closed-loop economy, and therefore the creation of closed water cycles in recent years, constitutes an element of the European Union's strategy and policy for inclusive and sustainable development [1, 2]. Due to climate change in the 21st century, wastewater treatment technologies

that allow for reuse and the creation of closed water cycles are being increasingly implemented [3–7]. In addition to wastewater reuse technologies, the countries with the greatest water shortages are using solutions to desalinate water from the seas and oceans [8–11], or rainwater management systems [12, 13]. One of the main constraints to the reuse of treated wastewater and public acceptance

in this regard is the lack of appropriate legislation at the European Union level [3]. Also, the high cost of treating treated wastewater to create closed water circuits or the use of technologies for desalinating water from the seas and oceans limits the widespread use of this type of technology [14–16]. However, in the future, creation of closed circuits and the reuse of wastewater is inevitable [17, 18]. Treated wastewater discharged from wastewater treatment plants cannot be used as drinking water, as it still contains too many contaminants, especially significant numbers of various microorganisms. However, there are technologies to obtain drinking water from wastewater [19]. These technologies, due to high economic costs or serious social disapproval, are currently used very rarely [20, 21], but the use of water diversion can increase the efficiency of water utilities [22]. A review of the treatment and use of treated wastewater, including health aspects, was made by Kesari et al. [23]. To date, treated wastewater discharged from wastewater treatment plants has been reused for, i.a. irrigating fields in agriculture, recharging groundwater resources, irrigating golf courses, washing vehicles, flushing toilets, extinguishing fires, construction work, or for cooling purposes in thermal power plants [24–27]. WHO data [28] shows that in 2006, more than 10% of the global population consumed the agricultural products that were grown by irrigating fields with treated wastewater.

In the 21st century, there has been an intense increase in the amount of treated wastewater being used. Aziz and Farissi [29] found that the

amount of treated wastewater that is reused in Europe, the United States and China is increasing by about 10–29% per year, and in Australia by as much as 41%. In contrast, Israel is the largest user of treated wastewater for agricultural land irrigation, where 90% of the reclaimed water originates from wastewater [30].

Currently, there are few scientific papers on the use of treated wastewater for toilet flushing, but this direction of wastewater management is likely to be developed in the future [23]. Therefore, it is important to conduct scientific research in this area to identify the appropriate technology for additional treatment of the treated wastewater for reuse in households.

The purpose of this study was to determine the performance of a novel installation for treating the outflow from a hybrid constructed wetland system and the possibility of reusing wastewater in the household. The research was carried out in a lodge building located in the Polesie National Park (PNP) in Poland.

MATERIALS AND METHODS

Characteristics of the experimental facility

The studied plant is located in Kulczyn by the PNP service settlement (51°23'7.01" N, 23°17'48.42" E) in Lubelskie Province in south-eastern Poland (Figure 1). The detailed location of the site was also described in earlier publications [31, 32]. The hybrid constructed wetland

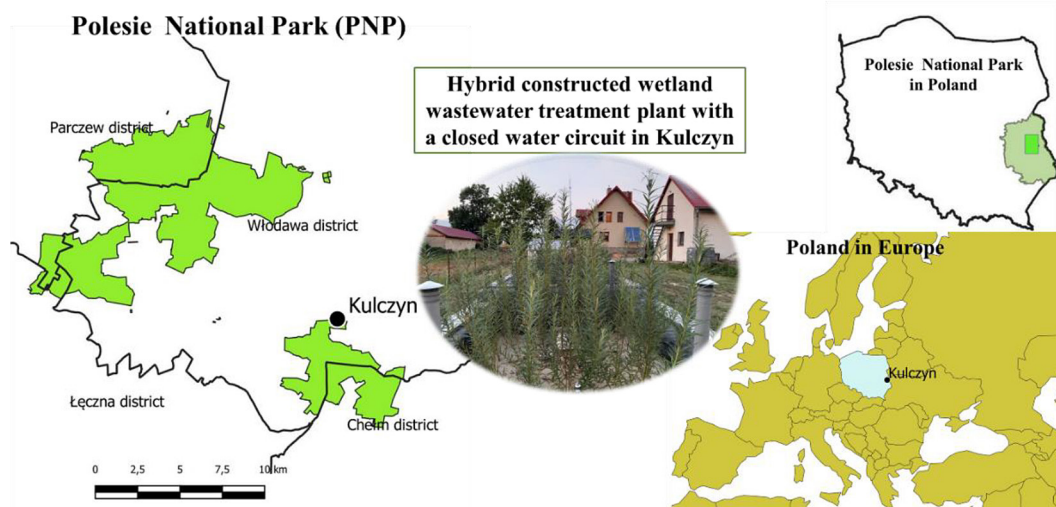

Figure 1. Location of hybrid constructed wetland system with a closed water circuit in Polesie National Park in Kulczyn (data from www.geoportal.gov.pl, www.mapsforeurope.org ©EuroGeographics2024)

system at PNP, from which wastewater is recycled and reused in the household, consists of five main components [32]:

- a 2-chamber primary settling tank with a capacity of 3.2 m³ integrated with a raw wastewater pumping station,
- soil-plant bed I with vertical flow of wastewater (VF) with an area of 12 m²,
- soil-plant bed II with horizontal flow of wastewater (HF) with an area of 15 m²,
- a system for returning and further treating the treated wastewater for reuse in the household,
- an absorption well for discharging excess treated wastewater into the ground (Figure 2).

The constructed wetland system was designed to treat the wastewater generated by 4 people, and its capacity was planned at 0.4 m³/day. During the study period, the average daily volume of wastewater delivered to the facility was 0.39 m³/d, and the hydraulic load I of the bed was 0.033 m³/m²/day. The efficiency of pollutant removal in the hybrid constructed wetland system is described in Myka-Raduj et al. [32].

This work analyzed the results of a study on the operation of a system for recycling and treating the wastewater discharged from a constructed wetland system. This system is an innovative solution that allows the reuse of wastewater in the household, especially for toilet flushing. The analyzed wastewater treatment system consists of 3 main components:

- 1) pumping station for treated wastewater (active volume = 0.39 m³) with submersible pump for recycling the treated wastewater to the residential building,
- 2) a whole-house filtration system comprising 3 filters and UV lamp for treatment of treated wastewater,
- 3) a hydrophore (150 l), which is a tank for storing and delivering the treated wastewater to the toilet tank.

Figure 3 shows a schematic diagram of the sanitary system with an installation for the treatment and reuse of treated wastewater in the residential building of the PNP service settlement in Kulczyn.

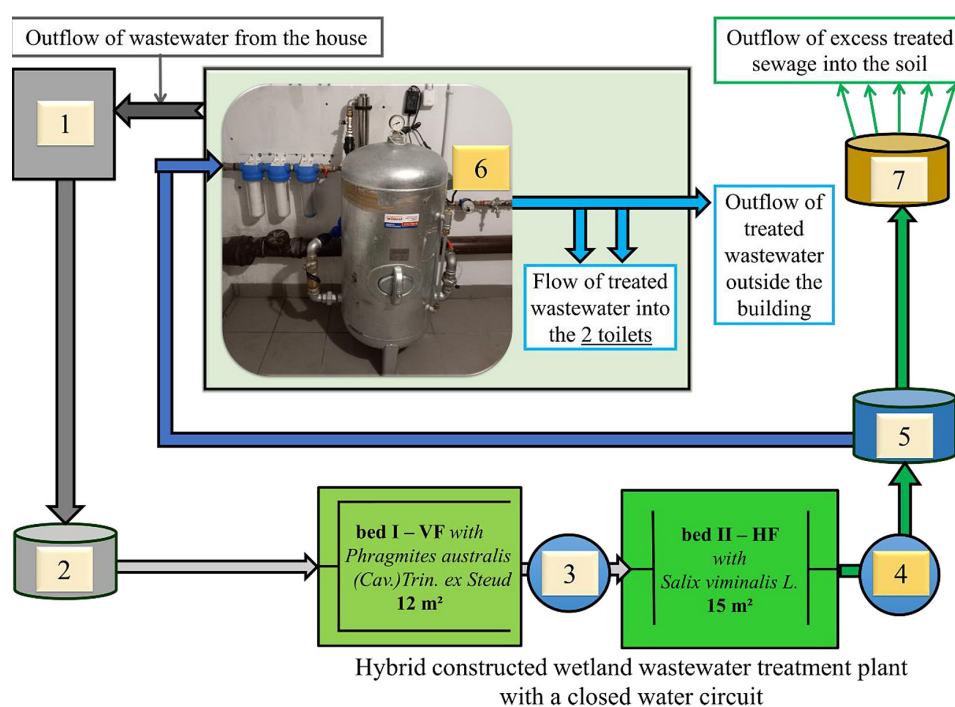

Figure 2. Diagram of the hybrid constructed wetland system in Kulczyn on the territory of the PNP integrated with the installation for the return and treatment of treated wastewater : 1 – 2-chamber primary settling tank; 2 – pumping station for VF type bed I; 3 – inspection well beyond the bed I; 4 – inspection well beyond the bed II; 5 – pumping station for treated wastewater for domestic reuse, 6 – tested treated wastewater treatment and system pressure maintenance system; 7 – absorption well for disposal of excess treated wastewater into the ground; gray line – inflow of wastewater to the treatment plant; green line – outflow of treated wastewater from the treatment plant; dark blue line – inflow of treated wastewater to the house; light blue line – inflow of treated wastewater to 2 toilets and outside the building

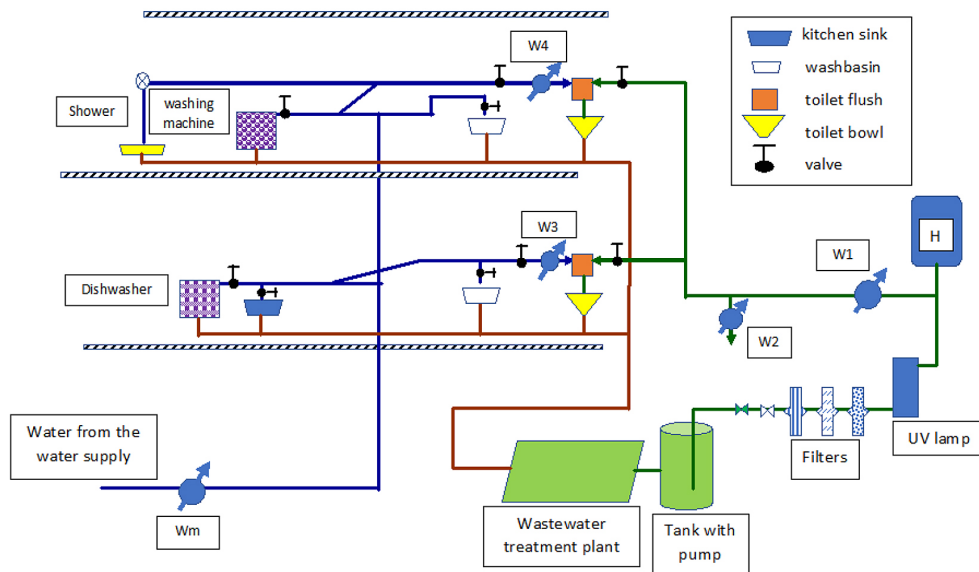

Figure 3. Diagram of the sanitary system and the system for treatment and reuse of treated wastewater in a residential building: Wm, W1, W2, W3 and W4 – water meters

Treated wastewater flowing out of the hybrid constructed wetland system is collected in a pumping station equipped with an Omnigena WQ 1500F submersible pump, which pumps the treated wastewater to the apartment building for further treatment and reuse. Excess unused treated wastewater is discharged into the ground via an absorption well (Figure 2).

The installation for treatment, storage and delivery of treated wastewater is installed in the basement of a residential building (Figure 4). The treated wastewater first flows through 3 filters from USTM Ltd, Poland, placed in whole-house filtration system housing in the following order: a 10” PP20 yarn filter, a 10” PS5 spun filter and a 10” BL10 carbon filter. The treated wastewater then flows through a Nordic Tec NT UV 25-PH lamp, PHILIPS TUV 25W T8-498 filament model (company NordicTec EU, Poland). The treated wastewater is collected in a vertical hydrophore tank with a capacity of 150 liters (model: Wimest ZCS/150/6, from WIMEST Spółka Jawna, Poland). The hydrophore tank is used to maintain adequate pressure so that the treated wastewater can flow to the 2 toilet tanks of the residential building: 1) on the second floor, 2) on the first floor, and to the tap valve that supplies the treated wastewater outside the building (Figures 2, 3).

Analytical methods

The study of the effectiveness of the treatment of wastewater from the hybrid constructed wetland system and the analysis of the possibility of

its reuse in households was conducted for a period of 15 months, i.e. from October 2022 to December 2023. During the study period, 14 series of physical, chemical and microbiological analyses were performed, during which 28 wastewater samples were examined. The wastewater samples for analysis were taken once a month (except for August 2023 – due to the holiday period and lack of wastewater) from 2 measurement points. The first sample was taken from the distribution sump downstream of the HF type bed II, and the second sample was taken from the tap valve located behind the hydrophore in the basement of the apartment building (Figure 2). Sampling and transport were carried out according to Polish Standards, which are in line with the American Public Health Association – APHA [33, 34]. The following physico-chemical parameters were determined in the collected wastewater samples: pH, dissolved oxygen concentration, total suspended solids, BOD₅, COD, total nitrogen and total phosphorus concentrations. The counts of *Escherichia coli* and fecal enterococci were also determined in wastewater samples, using a miniaturized method for detecting these bacteria in surface water and wastewater, determining the most probable number (MPN/in 100 ml) of these bacteria. Physical and chemical analyses were performed at the Laboratory of the Department of Environmental Engineering and Geodesy, and microbiological analyses were performed at the Department of Environmental Microbiology of the University of Life Sciences in Lublin (Poland). Analyses

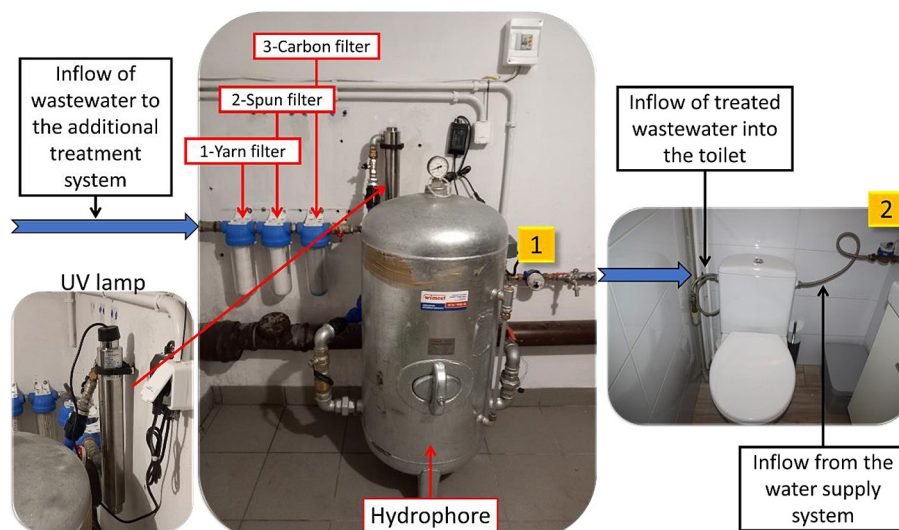

Figure 4. Installation for treatment, storage and delivery of treated wastewater installed in the basement of the building: 1 – water meter recording the amount of treated wastewater reused in the household; 2 – water meter recording the amount of water flowing from the water supply to the toilet

were performed on laboratory equipment according to commonly used methods (PN-EN ISO 10523:2012, PN-EN ISO 5814:2013-04, PN-EN 872:2007 + Apl:2007, PN-EN 1899-1:2002, 2:2002, PN-ISO 15705:2005, PN-C-04576-14:1973, PN-EN ISO 6878:2006 pt. 7 + Apl:2010 + AP2:2010, PN-EN ISO 9308-3:2002P, PN-EN ISO 7899-1:2002P) [35–43]. Measurement methods and measuring apparatus are described in detail in a previous publication [32].

On the basis of the analytical results obtained, the effects of pollutant removal in the plant under study were determined, as well as the suitability of the treated wastewater for reuse, such as for flushing toilets or watering plants. Simultaneously, the amount of reused treated wastewater in the household was determined during the same study period. The obtained test results were used to calculate: average, minimum and maximum concentrations of pollutant values and standard deviation. The normality of the distribution of the analytical results was checked using the Shapiro-Wilk test. Normal distribution was shown by the results, in the case of the wastewater before treatment for parameters, such as temperature, pH, total nitrogen and total phosphorus, while in the wastewater after treatment for: temperature, oxygen concentration, COD, total nitrogen and total phosphorus. Other parameters in both types of wastewater: suspended solids, BOD_5 , *Escherichia coli* and enterococci, or pH values in treated wastewater, did not show normal distribution. Due to the ambiguity of the distributions, a nonparametric Wilcoxon matched pair test for dependent

samples was used to compare wastewater parameters before and after treatment.

The average concentrations of the analyzed pollutant indicators in the effluent flowing out of the hybrid constructed wetland system (C_d) and in the effluent after treatment at the analyzed installation (C_o) were used to calculate the pollutant removal efficiency (η), according to Formula 1:

$$\eta = (C_d - C_o) \cdot 100\% / C_d \quad (1)$$

To calculate the amount of treated and recycled wastewater for household reuse, including the amount of wastewater reused for toilet flushing, a measuring apparatus consisting of 2 wing water meters with 1 dm³/pulse flow pulsers (METRON JS 1.0 17 Qn = 1.0 m³/h water meters by METRON Integrated Systems Factory Sp. z o. o., Toruń, Poland) was used. A Wi-Fi LIW-01 Supla Zamel pulse counter (Zamel Sp. z o.o. Pszczyna, Poland) was used for pulse recording, together with SUPLA software version 24.01.01 [www.supla.org.pl, accessed 14.01.2024]. The data were recorded automatically at a frequency of every 10 minutes in SUPLA CLOUD. The data was then downloaded to a computer hard drive and collected in Microsoft Excel 2010 and continuously monitored in the SUPLA application on mobile devices with Android software. The water meters were installed on a newly constructed internal water supply system in a residential building. The first water meter, located behind the water meter as shown in Figure 4 and in the diagram of Figure 3 (labeled W1), recorded the amount of all treated wastewater recycled for reuse

in the household. The second water meter, W2, was installed in front of the tap valve, supplying the treated wastewater outside the building for green watering or other use. Since there may be a shortage of treated wastewater for toilet flushing during periods of high temperatures, as a result of the intake of large amounts of water by plants overgrowing VF and HF beds and evapotranspiration, the classic connection of toilet tanks to the water supply system was left in the residential building. Water meters located in this way allow determining water consumption for various purposes, and above all determining the efficiency of the system operation in terms of saving tap water. The main water meter Wm installed at the water supply connection allows determining the amount of water consumed by residents for drinking, maintaining hygiene and cleanliness of the premises, and for laundry, dishwashing, as well as for any shortage of treated wastewater for toilet flushing (Figure 3).

RESULTS AND DISCUSSION

Amount of reused wastewater

The readings from the water meters shown in Figure 3 enabled to determine the amount of water consumed in the PNP lodge for various

purposes, as shown in Table 1. Column 3 shows how much water the residents of the analyzed house consumed for various purposes, collectively. Column 4 shows how much wastewater was recycled and treated for reuse. Columns 5 and 6 show the amount of recycled wastewater reused for flushing toilets and watering the garden. In turn, column 7 shows the amount of tap water used for toilet flushing.

Table 1 shows that the monthly consumption of the water influent from the analyzed water supply system ranged from 9.56 to 13.015 m³/month. The only exception was July, a holiday month, when consumption was only 7.753 m³/month. Taking into account the different number of days in a month, the average water consumption per day by residents was 0.351 m³/day, which, when calculated per person, amounted to 88 L/P/day. In reality, residents' water consumption is higher, as some of the water shown in column 4 in Table 1 was reused, owing to the return of treated wastewater. Considering the data in Table 1, it can be concluded that the daily water consumption of the residents will be 0.431 m³/day, and for one person 108 L/P/day. Similar consumption in the household in question (109 L/P/day) was reported in 2022 [31]. This is water consumption within

Table 1. Monthly tap water consumption and wastewater reuse based on readings from individual water meters

Year	Months	Q _W [m ³ /month]	Q _{WR} [m ³ /month]	Q _G [m ³ /month]	Q _T [m ³ /month]	Q _{WT} [m ³ /month]
1	2	3	4	5	6	7
2022	X	9.914	2.834	0.094	2.74	0.164
2022	XI	10.510	2.940	0	2.94	0.058
2022	XII	11.930	2.308	0.037	2.271	0
2023	I	11.989	2.772	0	2.772	0
2023	II	10.884	2.174	0.02	2.154	0
2023	III	12.180	2.511	0.02	2.491	0
2023	IV	9.874	2.601	0	2.601	0
2023	V	10.359	2.202	0.16	2.042	0
2023	VI	10.100	3.233	0.559	2.674	0
2023	VII	7.753	0.697	0.194	0.503	0.879
2023	VIII	11.001	1.287	0.04	1.247	1.432
2023	IX	11.253	2.059	0.061	1.998	0.469
2023	X	10.028	3.168	0	3.168	0
2023	XI	9.561	2.788	0.106	2.682	0.094
2023	XII	13.015	3.252	0	3.252	0.144
	Razem	160.351	36.826	1.291	35.535	3.24

Note: Q_W – the amount of water withdrawn from the water supply system, Q_{WR} – the total amount of wastewater recycled and treated for reuse, Q_G – the amount of wastewater recycled and used for garden watering, Q_T – the amount of wastewater recycled and used in toilets, Q_{WT} – the amount of water withdrawn from the water supply system for toilet flushing.

the range that is encountered in many homes in Poland [44]. Of course, water consumption in individual homes can vary considerably depending on the country and type of facilities [45–47]. According to the European Commission [2023], per capita water consumption in Europe ranges from 50 to more than 250 L/d, and water consumption level in Poland was set at 100–125 L/d of water per capita. Thus, the result on per capita water consumption obtained in the surveyed household is within the range given by the European Commission [48].

The consumption of treated wastewater for garden watering at the analyzed premises was marginal (Table 1). A higher consumption of treated wastewater for watering the garden exceeding 0.5 m³ was observed only in June. The most relevant data, which indicate the actual savings in water supply consumption and justification for the application of the analyzed solution, can be found in column 6 of Table 1. Monthly consumption of wastewater recycled for toilet flushing ranged from 0.503 m³/month (in July) to 3.252 m³/month (in December 2023). The average share of water used in toilets in total water consumption is 19.67%, and the share of wastewater recycled from the treatment plant for toilet flushing is 18.0%. On the other hand, the total amount of wastewater recycled and used for flushing toilets and watering the garden accounts for an average of 18.7% of the amount of water consumed in the

analyzed household. A very good illustration of the savings in water consumption due to the reuse of wastewater is shown in Figures 5 and 6, where the variation in the amount of water consumed and wastewater recycled in different months of the year is presented.

Composition of treated wastewater and effects of pollutant removal

In addition to the quantitative characteristics of the wastewater recycled for reuse, its qualitative parameters are important. Descriptive statistics of selected physico-chemical and microbiological indicators in the treated wastewater flowing out of the constructed wetland system as well as in the wastewater recycled and treated in the installation under study are shown in Table 2. In turn, Figure 7 shows the dynamics of changes in the concentration of the studied parameters in the treated wastewater during the study period.

The study shows that the pH of the treated wastewater discharged from the hybrid constructed wetland system was weakly alkaline and ranged from 7.04 to 7.67, which was similar to that recorded in the wastewater discharged from other hybrid constructed wetland systems [49, 50]. On the other hand, the pH in treated wastewater discharged from the studied treatment system and reuse differed slightly and ranged from 7.24 to 7.65. According

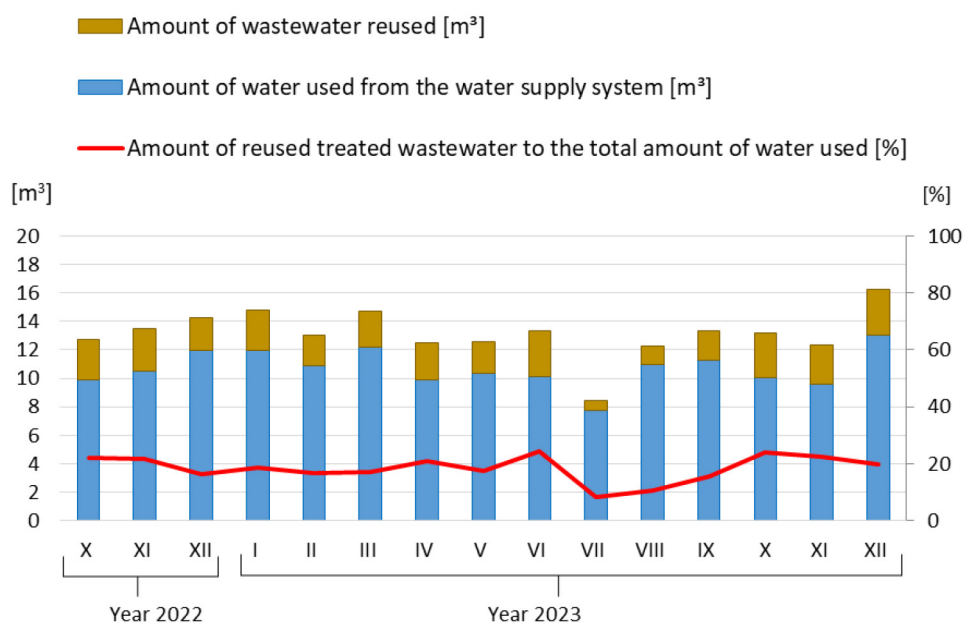

Figure 5. Changes in the amount of tap water used and wastewater recycled for reuse in different months of the year

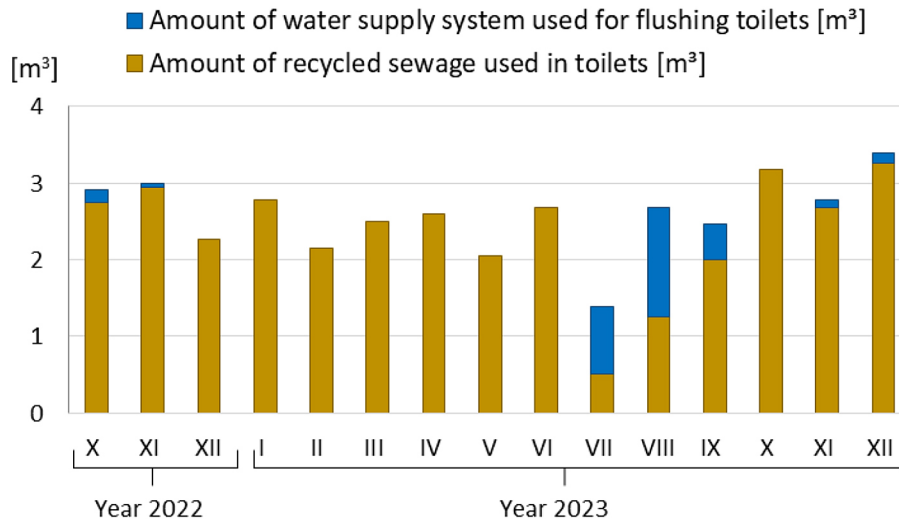

Figure 6. Changes in the amount of wastewater recycled and tap water used to flush the toilet in different months of the year

Table 2. Composition of inflow (W_{IN}) and outflow (W_{OUT}) wastewater from the plant under study

Parameter (unit)	Wastewater type	Min.	Max.	Mean	Median	Standard deviation	Coefficient of variation	Wilcoxon z p-value
pH value	W_{IN}	7.04	7.67	–	–	–	–	z = -1,558 p = 0.072
	W_{OUT}	7.24	7.65	–	–	–	–	
Dissolved oxygen (mg/l)	W_{IN}	0.94	4.39	2.88	3.23	1.08	0.37	z = -2,956 p = 0.006*
	W_{OUT}	2.36	5.01	3.96	4.07	0.70	0.18	
Total suspended solids (mg/l)	W_{IN}	2.00	30.00	11.18	10.00	9.64	0.86	z = 2.783 p = 0.008*
	W_{OUT}	1.56	26.67	5.95	3.48	7.58	1.27	
BOD ₅ (mg/l)	W_{IN}	0.94	9.98	6.90	7.66	2.61	0.38	z = 4,619 p = 0.0002*
	W_{OUT}	0.12	8.82	3.74	3.12	2.55	0.68	
COD (mg/l)	W_{IN}	22.70	79.00	40.37	33.50	17.02	0.42	z = 3.320 p = 0.003*
	W_{OUT}	15.00	55.40	31.19	31.60	11.31	0.36	
Total nitrogen (mg/l)	W_{IN}	18.00	50.50	36.13	37.50	8.18	0.23	z = 1.476 p = 0.082
	W_{OUT}	14.70	49.40	34.36	34.95	9.56	0.28	
Total phosphorus (mg/l)	W_{IN}	1.78	7.24	4.00	4.11	1.35	0.34	z=1.737 p=0.053
	W_{OUT}	0.98	7.60	3.35	3.66	13677	0.58	
<i>E. coli</i> CFU/100 mL	W_{IN}	0	48000	6570	820	1428	2.08	z = 1.873 p = 0.042*
	W_{OUT}	0	820	477	0	1.32	2.99	
Fecal enterococci CFU/100 mL	W_{IN}	0	1440	1750	510	3911	2.23	z = 1.628 p = 0.064
	W_{OUT}	0	480	50	0	131	2.63	

to the Levi Strauss & Company [51], the pH value in wastewater used for toilet flushing again should approximate 6.0–9.0. Therefore, the pH of wastewater recycled for reuse at the studied installation is within the stated range. The concentration of dissolved oxygen in wastewater discharged from the analyzed constructed wetland system ranged from 0.94–4.39 mg/L, and averaged 2.88 mg/L (Table 2). Similar dissolved

oxygen concentrations (2.78–3.87 mg/L) in the wastewater discharged from 2 hybrid constructed wetland systems with vertical and horizontal flow were found by Józwiakowski [49]. In contrast, significantly higher dissolved oxygen contents (4.90–7.24 mg/L) in wastewater discharged from 2 hybrid constructed wetland systems in Roztocze National Park over a 3-year study period were reported by Micek et al. [50]. An increase

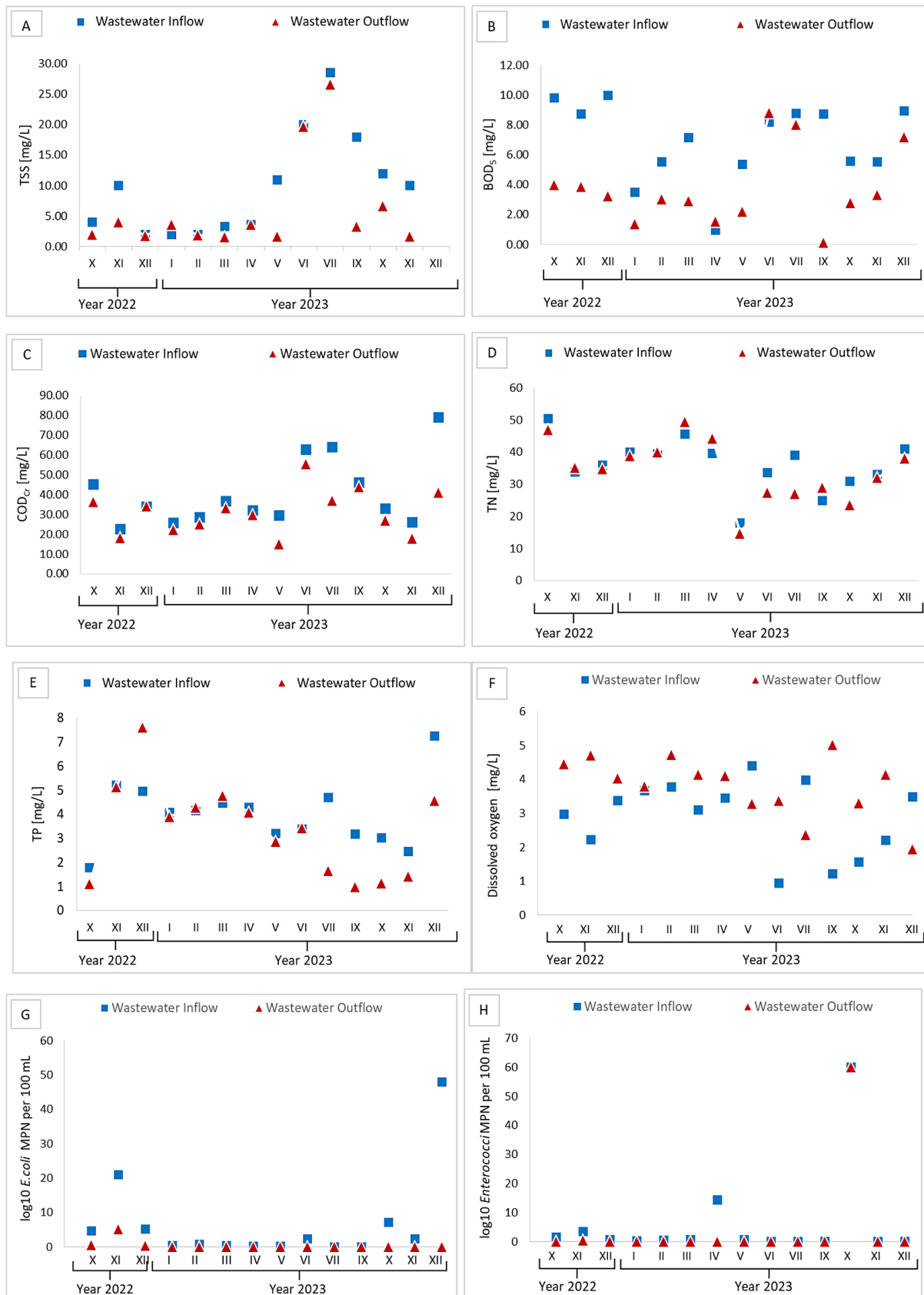

Figure 7. The dynamics of changes in the concentration of the studied physico-chemical (A-F) and microbiological (G-H) in treated wastewater during the study period: A – total suspended solids (TSS), B – biochemical oxygen demand (BOD₅), C – chemical oxygen demand (COD_{Cr}), D – total nitrogen (TN), E – total phosphorus (TP), F – dissolved oxygen, G – *Escherichia coli* bacteria (*E. coli*), H – *Enterococcus faecalis* bacteria (*Enterococci*)

in dissolved oxygen concentration was recorded in the effluent after treatment at the analyzed plant, which ranged from 2.36 to 5.01 mg/L during the study period and averaged 3.96 mg/L. The increase in the concentration of dissolved oxygen in the wastewater after the treatment system was probably due to its dissolution in the hydrophore due to the contact between water and air at elevated pressure. According to Levi Strauss & Company [51], no requirements were specified for dissolved oxygen in wastewater used for toilet flushing again. Figure 8 shows the changes in air temperature and dissolved oxygen concentration in recycled treated wastewater. During the conducted research, it was found that in the recycled wastewater, during the spring and summer months (from May to July 2023), the

dissolved oxygen concentration decreased when the air temperature increased.

Figure 9 shows the efficiency of removal of selected pollutant indicators from wastewater in the studied installation. The concentrations of the main pollutant indicators in the outflow from the constructed wetland system, namely total suspended solids, BOD₅ and COD, showed low values and were well below the requirements specified for treated wastewater discharged from this type of treatment plant. The content of total suspended solids in the outflow from the constructed wetland system ranged from 2–30 mg/L, and averaged 11.2 mg/L (Table 2). The highest contents of total suspended solids were recorded in summer – from June to September – and the lowest in autumn and winter (Figure 7A). A slightly higher

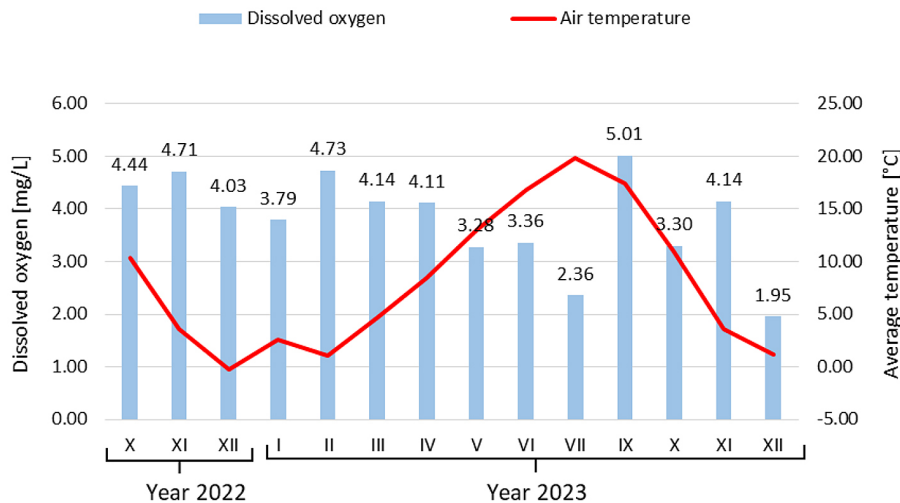

Figure 8. Changes in air temperature and dissolved oxygen concentration in treated wastewater recycled for reuse during the study period

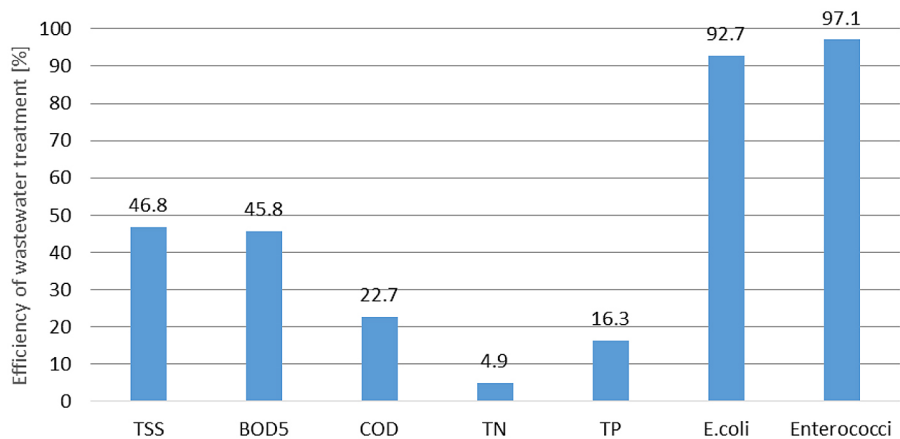

Figure 9. Efficiency of removal of selected pollutant indicators from wastewater in the studied installation: TSS – total suspended solids, BOD₅ – biochemical oxygen demand, COD – chemical oxygen demand, TN – total nitrogen, TP – total phosphorus, E. coli – *Escherichia coli*, Enterococci – *Enterococcus faecalis*.

average concentration of total suspended solids (16.4–17.8 mg/L) in wastewater discharged from 2 hybrid constructed wetland VF-HF systems was recorded by Józwiakowski [49]. In contrast, the content of total suspended solids in the wastewater discharged from 2 hybrid constructed wetland systems in Roztocze National Park during the 3-year study period was 9.9–26.7 mg/L [50].

The treated wastewater at the analyzed installation showed a decrease in total suspended solids, which ranged from 1.6 to 26.7 mg/L during the study period and averaged 5.9 mg/L (Table 2). Therefore, these values were well below 30 mg/L, the maximum value required for total suspended solids in the wastewater reused for toilet flushing [51].

The data obtained show that the treatment system studied provided an average decrease of total suspended solids of 46.8% (Figure 9). This was due to the effective operation of the series filtration system. Figure 10 shows the system of 3 series filters immediately after installation (A) and at the end of the service life (B). The tests showed that the filter cartridges needed to be replaced at least once a month due to pronounced fouling, which had the effect of significantly reducing the flow capacity of the wastewater and increasing the content of total suspended solids in the outflow. Thus, the observation shows that the service life of the filters was considerably shorter than the manufacturer's assumption (6 months). However, such a lifetime was specified for clean water. Thus, in the case of wastewater recycled from the treatment plant, the lifetime of the filters is significantly reduced. When analyzing the data in Table 1, it can be concluded that the tested filter system allowed the treatment of 2.630 m³ of wastewater per month, which was reused in the

household. The distribution of BOD₅ values in the outflow from the constructed wetland system during the study period is shown in Figure 7B. The BOD₅ values in the effluent from the constructed wetland system ranged from 0.94 to 9.98 mg/L, and averaged 6.90 mg/L (Table 2). Slightly higher average BOD₅ values (10.8–11.1 mg/L) in the wastewater discharged from 2 VF-HF hybrid constructed wetland systems were reported by Józwiakowski [49]. In contrast, the average BOD₅ values in wastewater discharged from 2 hybrid constructed wetland systems in Roztocze National Park during the 3-year study period were 3.0–3.5 mg/L [50]. The treated wastewater at the analyzed installation showed a decrease in BOD₅ values, which ranged from 0.12 to 8.82 mg/L during the study period, and averaged 3.74 mg/L (Table 2). Therefore, these values were well below 30 mg/L, the maximum value required for BOD₅ in the wastewater reused for toilet flushing [51]. From the data obtained, it can be seen that the treatment system studied provided an average BOD₅ reduction of 45.8%, which was similar to that obtained for total suspended solids (Figure 9). The distribution of COD values in the outflow from the constructed wetland system during the study period is shown in Figure 7C. The COD values in the treatment plant effluent ranged from 22.7–79 mg/L, and averaged 40.4 mg/L (Table 2). Smaller average COD values (29.1–36.9 mg/L) in the effluent discharged from the 2 VF-HF hybrid constructed wetland systems were reported by Józwiakowski [49]. In contrast, the average COD values in the wastewater discharged from 2 hybrid constructed wetland systems in Roztocze National Park during the 3-year study period were 15.2–34.8 mg/L [50].



Figure 10. Whole-house filtration system consisting of 3 filters (filters from left to right: yarn, spun, carbon): A – clean filters immediately after installation, B – dirty filters requiring replacement

The treated wastewater at the analyzed installation showed a slight decrease in COD values, which ranged from 15 to 55.4 mg/L during the study period and averaged 31.2 mg/L (Table 2). According to Levi Strauss & Company [51], no requirements have been set for COD in the wastewater reused for toilet flushing. From the data obtained, it can be seen that the treatment system studied provided a small average COD reduction of 22.7%, which was significantly lower than that for total suspended solids and BOD₅ (Figure 9).

Relatively small treatment effects were obtained for total nitrogen and total phosphorus. This is understandable, since nitrogen is removed only by biological means and most often by nitrification and denitrification, or is incorporated into the bacterial cells of various types of microorganisms. In the case of the system under study, wastewater treatment takes place through physical processes (filtration), so both nitrogen and phosphorus are retained together only with suspended particles as their component.

Changes in the concentration of total nitrogen in treated wastewater during the study period are shown in Figure 7D. The concentration of total nitrogen in the effluent from the treatment plants ranged from 18–50.5 mg/L, with an average of 36.1 mg/L (Table 2). Similar average concentrations of total nitrogen (26.0–53.0 mg/L) in the wastewater discharged from 2 VF-HF hybrid constructed wetland systems were reported by Józwiakowski [49]. On the other hand, the content of total suspended solids in the wastewater discharged from 2 hybrid constructed wetland wastewater treatment plants in Roztocze National Park during the 3-year study period was 13.8–39.9 mg/L [50].

The treated wastewater at the analyzed plant showed a decrease in total nitrogen concentration, which ranged from 14.7–49.4 mg/L during the study period and averaged 34.4 mg/L (Table 2). According to Levi Strauss & Company [51], no requirements have been set for total nitrogen in the wastewater reused for toilet flushing. From the data obtained, it can be seen that the treatment system tested provided a small removal of total nitrogen – 4.9% – which was significantly lower than the previously described pollutant indicators (Figure 9).

Changes in the concentration of total phosphorus in treated wastewater during the study period are shown in Figure 7E. The concentration

of total phosphorus in the effluent from the constructed wetland systems ranged from 1.78–7.24 mg/L, with an average of 4.00 mg/L (Table 2). Similar average concentrations of total phosphorus (1.4–6.4 mg/L) in the wastewater discharged from 2 VF-HF hybrid constructed wetland systems were reported by Józwiakowski [49]. On the other hand, the content of total suspended solids in the wastewater discharged from 2 hybrid constructed wetland systems in Roztocze National Park during the 3-year study period was 1.1–2.6 mg/L [50].

The treated wastewater at the analyzed plant showed a decrease in the concentration of total phosphorus, which ranged from 0.98–7.6 mg/L during the study period and averaged 3.35 mg/L (Table 2). According to Levi Strauss & Company [51], no requirements have been set for total phosphorus in the wastewater reused for toilet flushing. From the data obtained, it appears that the treatment system studied provided a small removal of total phosphorus – 16.3% (Figure 9). The elimination of microorganisms in the studied plant occurred primarily by means of a UV lamp. The growth of *E. coli* bacteria in the environment is affected by temperature, pH, salinity and intensity of sunlight, among other factors [52, 53]. According to Duque-Sarango et al. [54] the bactericidal effect of UV light is related to the direct photochemical breakdown of nucleic acids. However, it is known that some microorganisms are able to repair the UV-induced damage using photolysis or a light-independent mechanism [54]. In addition, bacteria in the environment can develop specific resistance to UV disinfection processes [54, 55].

On the basis of the microbiological analyses performed, there were varying numbers of *E. coli* bacteria and fecal enterococci in the wastewater before and after application of the filtration system and UV lamp irradiation (Table 2). Simultaneously, after application of the treatment system, the abundance of these bacteria significantly decreased or their presence was not detected at all (Figure 7G and 7H). During the experiment on 10–12.2022 and 03.2023 and 06.2023, *E. coli* bacteria were detected in the wastewater after application of the treatment system, with their abundance being 75.23 to 100% lower than before its application. In the case of enterococci, their presence in the wastewater after application of the treatment system was found on 10–12.2022 and 02.2023.

As in the case of *E. coli* bacteria, their abundance also decreased by 85.88–100% (Figure 7H). Only in the wastewater sample of 10.2023 the abundance of enterococci was the same before and after the application of the treatment system. Such results in Oct. 2023 were due to the failure of the UV lamp.

The average abundance of fecal enterococci in the effluent from the tested system was 50 CFU/100 mL, so it was significantly lower than 200 CFU/100 mL, the value required for these bacteria in the wastewater reused for toilet flushing [51]. It was determined that the use of the tested treatment system provided a high reduction of *E. coli* bacteria and enterococci, which averaged 92.74% and 97.14%, respectively.

Table 2 presents the results of the paired Wilcoxon non-parametric test, which allows statistical analysis of the performance of the treatment system under test. The null hypothesis was that – the average values of the indicators before and after the treatment system are equal – i.e. it can be interpreted as if the water treatment system was not effective. The results of the test were given in the form of a test statistic z and a p value. The values obtained were found to be less than the significance level taken as 0.05 for oxygen concentration, total suspended solids, BOD_5 , COD and *E. coli* bacteria. The 0.05 level was slightly exceeded for total phosphorus and enterococci. In summary, it can be concluded that the differences of these indicators before the treatment system and after the treatment system are statistically significant, i.e. that the tested treatment system is effective and can be used in similar cases. In order to assess the susceptibility of wastewater to biological treatment processes, the ratios between the various pollutant indicators were also analyzed. It was found that for the effluent flowing out of the constructed wetland system, the ratio of COD: BOD_5 was 5.85, and after additional treatment, it was also 5.85. The ratios of $BOD_5:N_{tot}$ and $BOD_5:P_{tot}$ were 0.19 and 0.19, as well as 1.72 and 1.73, respectively. As it can be seen, the applied filtration and disinfection processes did not change the magnitude of the ratios between the individual indicators. During wastewater treatment, natural biological processes cause mineralization of readily decomposable organic compounds leading to a natural increase in the COD/ BOD_5 ratio. Depending on the wastewater treatment method used, the suggested $BOD/N_{tot}/P_{tot}$ ratio in aerobic treatment is

defined as 100:5:1 [56], and in anaerobic processes as 300:1:0.1 [57]. The increase in the COD/ BOD_5 ratio along the treatment line is defined as a measure of progressive water stability [58]. In raw wastewater, the COD/ BOD_5 ratios are usually 2.0–2.5, although they can fluctuate significantly [59, 60]. However, this ratio always increases during the course of biological processes, and, as in this case, can exceed the values of 5.85. Such water during retention in reservoirs shows higher stability, so biological change processes are very slow. Therefore, any action that requires the necessary adjustments to improve its quality can only be carried out by physical or chemical processes.

CONCLUSIONS

On the basis of the performed study, it was found that the analyzed installation, consisting of a series system of 3 filters and a UV lamp, provided very high results in reducing microbiological indicators, namely *Escherichia coli* and enterococcus bacteria, which averaged 92.7 and 97.1%, respectively. It was noted that the average efficiency of reduction of total suspended solids and BOD_5 in the studied plant was 46.8 and 45.8%, respectively. Small effects were obtained for the reduction of COD (22.7%), total nitrogen (4.9%) and total phosphorus (16.3%). It was shown that the treated outflow discharged from the hybrid constructed system met the requirements set by Levi Strauss & Company for the wastewater reused for toilet flushing in terms of the selected studied indicators. It was found that the tested whole-house filtration system consisting of 3 filters (in the following arrangement: yarn, spun and carbon) allowed treating an average of 2630 m³ of wastewater per month. According to the study, however, the filter cartridges used needed to be replaced at least once a month due to pronounced fouling, which had the effect of significantly reducing the flow capacity of the wastewater and increasing the content of total suspended solids in the outflow. It was determined that the recycled treated wastewater could replace an average of 18.7% of the good quality water supplied by the water supply system in the studied household. However, the study and observations show that further research of recycled wastewater treatment systems for reuse is needed to achieve even better parameters of treated wastewater.

Acknowledgments

This study is a result of cooperation with Polesie National Park based in Urszulin. The authors would like to thank the Director and staff of PNP for creating a climate for creative work.

Results of research reported in the present paper was conducted as part of the doctoral thesis written by Eng. Anna Myka-Raduj, MSc, under project no. DWD/4/88/2020 entitled “Design, construction and an analysis of the operation of a hybrid constructed wetland with a closed water circuit in the Polesie National Park”, financed by the Polish Ministry of Education and Science.

REFERENCES

1. Europe 2020. A strategy for smart, sustainable and inclusive growth, Document 52010DC2020, <https://eur-lex.europa.eu/legal-content/EN/TXT/?uri=celex%3A52010DC2020>
2. Calisto F.M., Vermeulen W., Salomone R. Analysing European Union circular economy policies: words versus actions. *Sustainable Production and Consumption* 2020, 27: 337–353.
3. Angelakis A.N., Bontoux L., Lazarova V. Challenges and perspectives for water recycling and reuse in EU countries. *Water Supply* 2003, 3: 59–68.
4. Bixio D., Thoeye C., Wintgens T., Ravazzini A., Miska V., Muston M., Chikurel H., Aharoni, A., Joksimovic, D., Melin T. Water reclamation and reuse: Implementation and management issues. *Desalination* 2008, 218: 13–23.
5. Voulvoulis N. Water reuse from a circular economy perspective and potential risks from an unregulated approach. *Curr. Opin. Environ. Sci. Health* 2018, 2: 32–45.
6. Sapkota A.R. Water reuse, food production and public health: Adopting transdisciplinary, systems-based approaches to achieve water and food security in a changing climate. *Environ. Res.* 2019, 171: 576–580.
7. Hagenvoort J., Ortega-Reig M., Botella S., García C., de Luis A., Palau-Salvador G. Reusing Treated Waste-Water from a Circular Economy Perspective—The Case of the Real Acequia de Moncada in Valencia (Spain). *Water* 2019, 11: 1830.
8. Shevah Y. Water scarcity, water reuse, and environmental. *Saf. Pure Appl. Chem.* 2014, 86: 1205–1214.
9. Al-Othman A., Darwish N.N., Qasim M., Tawalbeh M.; Darwish N.A., Hilal N. Nuclear desalination: A state-of-the-art review. *Desalination* 2019, 457: 39–61.
10. Ungureanu N., Vladut V., Voicu G. Water scarcity and wastewater reuse in crop irrigation. *Sustainability* 2020, 12: 9055.
11. Curto D., Franzitta V., Guercio A. A Review of the water desalination technologies. *Appl. Sci.* 2021, 11: 670.
12. Palla A., Gnecco I., Lanza L., La Barbera P. Performance analysis of domestic rainwater harvesting systems under various European climate zones. *Resour. Conserv. Recycl.* 2012, 62: 71–80.
13. Musayev S., Burgess E., Mellor J. A global performance assessment of rainwater harvesting under climate change. *Resour. Conserv. Recycl.* 2018, 132: 62–70.
14. Ghaffour N., Missimer T.M., Amy G.L. Technical review and evaluation of the economics of water desalination: Current and future challenges for better water supply sustainability. *Desalination* 2013, 309: 197–207.
15. Guo T., Englehardt J., Wu T. Review of cost versus scale: Water and wastewater treatment and reuse processes. *Water Sci. Technol.* 2014, 69: 223–234.
16. Gao L., Yoshikawa S., Iseri Y., Fujimori S., Kanae S. An economic assessment of the global potential for sea water desalination to 2050. *Water* 2017, 9: 763.
17. Maquet Ch. Wastewater reuse: a solution with a future. *Field Actions Science Reports. Special Issue 22, Water, Waste & Energy: Prospects for essential services in Africa* 2020, 64–67.
18. Silva J.A. Water supply and wastewater treatment and reuse in future cities: a systematic literature review. *Water* 2023, 15: 3064.
19. Tang C.Y., Yang Z., Guo H., Wen J.J., Nghiem L.D., Cornelissen E. Potable water reuse through advanced membrane technology. *Environ. Sci. Technol.* 2018, 52(18): 10215–10223.
20. Dolnicar S., Saunders, C. Recycled water for consumer markets a marketing research review and agenda. *Desalination* 2006, 187: 203–214.
21. Harris-Lovett S.R., Binz C., Sedlak D.L., Kiparsky M., Truffer B. Beyond user acceptance: a legitimacy framework for potable water reuse in California. *Environmental Science & Technology* 2015, 49: 7552–7561.
22. Cagno E, Garrone P, Negri M, Rizzuni A. Adoption of water reuse technologies: An assessment under different regulatory and operational scenarios. *J Environ Manage* 2022, 317: 115389.
23. Kesari K.K., Sani R., Jamal Q.M.S., Tripathi P., Lae J.A., Jha N.K., Siddiqui M.H., Kumar P., Tripathi V., Ruokolainen J. Wastewater treatment and reuse: a review of its applications and health implications. *Water Air Soil Pollut* 2021, 232: 208.
24. Katsoyiannis I.A., Gkotsis P., Castellana M., Cartechini F., Zouboulis A.I. Production of demineralized water for use in thermal power stations by advanced treatment of secondary wastewater effluent. *Journal of Environmental Management* 2017, 1(190): 132–139.
25. Mohsen M.S. Treatment and reuse of industrial effluents: Case study of a thermal power plant.

- Desalination 2004, 167: 75–86.
26. Smith R.G. 1995. Water reclamation and reuse. *Water Environment Research* 67, 488–495.
 27. Yang J., Jia R., Gao Y., Wang W., Cao P. The reliability evaluation of reclaimed water reused in power plant project. *IOP Conference Series: Earth and Environmental Science* 2017, 100: 012189.
 28. WHO – World Health Organization, 2006. Guidelines for the Safe Use of Wastewater, Excreta and Greywater. In *Wastewater Use in Agriculture* (2nd ed.).
 29. Aziz F., Farissi M. Reuse of treated wastewater in agriculture: Solving water deficit problems in arid areas. *Ann. West Univ. Timisoara Ser. Biol.* 2014, 17: 95–110.
 30. Angelakis A., Snyder S. Wastewater treatment and reuse: Past, present, and future. *Water* 2015, 7: 87–95.
 31. Myka-Raduj A., Józwiakowski K., Siwiec T., Raduj W. Changes of Water Consumption in a Forrester’s Lodge in Polesie National Park (Poland)—Case Study. *Water* 2023, 15: 3157. <https://doi.org/10.3390/w15173157>
 32. Myka-Raduj A., Bohacz J., Listosz A., Raduj W., Józwiakowski K. 2024. Efficiency of operation a hybrid constructed wetland located in the Polesie National Park (Poland) during the start-up period. *Journal of Ecological Engineering* 2024, 25(6): 292–311 <https://doi.org/10.12911/22998993/187962>
 33. American Public Health Association (APHA) 1992. Standard Methods for the Examination of Water and Wastewater. 18th Edition, American Water Works Association (AWWA) and Water Pollution Control Federation (WPCF), Washington DC.
 34. American Public Health Association (APHA) 2005. Standard Methods for the Examination of Water and Wastewater. 21st Edition, American Water Works Association/Water Environment Federation, Washington DC.
 35. PN-EN ISO 10523:2012. Water quality. Determination of ph. Electrochemical sensor method.
 36. PN-EN ISO 5814:2013-04. Water quality. Determination of dissolved oxygen - Electrochemical sensor method.
 37. PN-EN 872:2007+Apl: 2007. Water quality. Determination of suspensions. Method using filtration through glass fiber filters.
 38. PN-EN 1899-1:2002, 2:2002. Water quality. Determination of biochemical oxygen demand after n days (BOD_n). Part 1: Dilution and grafting method with the addition of allylthiourea.
 39. PN-ISO 15705: 2005. Water quality. Determination of the chemical oxygen demand index (SP-COD). Miniaturized method using tight test tubes.
 40. PN-C-04576-14:1973. Water and sewage - Testing the content of nitrogen compounds - Calculation of total nitrogen.
 41. PN-EN ISO 6878:2006 pkt 7 +Ap1:2010+ AP2:2010. Water quality - Determination of phosphorus - Spectrometric method with ammonium molybdate.
 42. PN-EN ISO 9308-3:2002P. Water quality - Detection and quantification of *Escherichia coli* and coliforms - Part 3: Miniaturized method for the detection and enumeration of E-Coli in surface water and wastewater (most probable bacterial count).
 43. PN-EN ISO 7899-1:2002P. Water quality - Detection and enumeration of fecal enterococci - Part 1: Miniaturized method for testing surface water and wastewater (most probable number of bacteria).
 44. Bugajski P.M., Kurek K., Młyński D, Operacz A. Designed and real hydraulic load of household wastewater treatment plants. *Journal Of Water And Land Development* 2019, 40 (1–3): 155–160.
 45. Pawelek J., Bergel T., Woyciechowska O. Variation in water consumption in rural households during the multi-year period. *Acta Scientiarum Polonorum. Formatio Circumiectus* 2015, 14(4): 85–94 (in Polish).
 46. Bergel T., Szelağ B., Woyciechowska O. Influence of a season on hourly and daily variations in water demand patterns in a rural water supply line – case study. *Journal of Water and Land Development* 2017, 34: 59–64.
 47. Crouch M.L., Jacobs H.E., Speight V.L. Defining domestic water consumption based on personal water use activities. *Journal of Water Supply: Research and Technology-Aqua* 2017, 70(7): 1002–1011.
 48. European Commission, Eurostat. 2023. Available online: <https://ec.europa.eu/eurostat/data/database> (accessed on 1 July 2023).
 49. Józwiakowski K. Studies on the efficiency of sewage treatment in chosen constructed wetland systems. *Infrastruct. Ecol. Rural. Areas* 2012, 1: 232 (In Polish).
 50. Micek A., Józwiakowski K., Marzec M., Listosz A. Technological reliability and efficiency of wastewater treatment in two hybrid constructed wetlands in the Roztocze National Park (Poland). *Water* 2020, 12: 3435. <https://doi.org/10.3390/w12123435>
 51. Levi Strauss & Company 2016. Recycle and reuse standard and guidelines. <https://www.levistrauss.com/wp-content/uploads/2019/03/Laundry-Recycle-and-Reuse-Manual-LSCo-2016.pdf>
 52. Blaustein R.A., Pachepsky Y., Hill R.L., Shelton D.R., Whelan, G. *Escherichia coli* survival in waters: Temperature dependence. 2013, *Water Research* 2013, 47(1): 569–578. <https://doi.org/10.1016/j.watres.2012.10.027>
 53. Chen P.-Y., Chu X.-N., Liu L., Hu J.-Y. Effects of salinity and temperature on inactivation and repair potential of *Enterococcus faecalis* following medium- and low-pressure ultraviolet irradiation. *Journal of Applied Microbiology* 2016, 120(3): 816–825. <https://doi.org/10.1111/jam.13026>

54. Duque-Sarango, P., Romero-Martínez, L., Pinos-Vélez, V., Sánchez-Cordero, E., Samaniego, E. Comparative study of UV radiation resistance and reactivation characteristics of *E. coli* ATCC 8739 and native strains: Implications for water disinfection. *Sustainability* 2023, 15: 9559. <https://doi.org/10.3390/su15129559>
55. Maghsoodi M., Lowry G.L., Smith I.M., Snow S.D. Evaluation of parameters governing dark and photo-repair in UVC-irradiated *Escherichia coli*. *Environ. Sci.* 2022, 8: 407–418.
56. Slade A.H., Thorn G.J.S., Dennis M.A. The relationship between BOD:N ratio and wastewater treatability in a nitrogen-fixing wastewater treatment system. *Water Science and Technology* 2011, 63(4): 627–632, <https://doi.org/10.2166/wst.2011.215>
57. Hussain A., Kumar P., Mehrotra. Nitrogen and phosphorus requirement in anaerobic process: a review. *Environmental Engineering and Management Journal* 2015, 14(4): 769–780, <https://doi.org/10.30638/eemj.2015.086>
58. Coccu R., Lai T., Sandom A. Standardization of BOD₅/COD ratio as a biological stability index for MSW. *Waste Management* 2012, 32(8): 1503–1508, <https://doi.org/10.1016/j.wasman.2012.04.001>
59. Bader A.C., Hussein H.J., Jabbar M.T. BOD: COD ratio as indicator for wastewater and industrial water pollution. *International Journal of Special Education* 2022, 37(3): 2164–2171.
60. Siwiec T., Reczek L., Michel M.M., Gut B., Hawerstrojek P., Czajkowska J., Józwiakowski K., Gajewska M., Bugajski P. Correlations between organics indicator in municipal wastewater. *Archives of Environmental Protection* 2018, 44(4): 50–57, <https://doi.org/10.24425/aep.2018.122296>