

Studies on Moisture Effects on Powder Flow and Mechanochemical Improvement of Powder Flowability

Ireneusz Opaliński¹, Marcin Chutkowski^{1*}, Mateusz Stasiak²,
Karolina Leś¹, Marcin Olechowski³, Mateusz Przywara¹

¹ Department of Chemical and Process Engineering, Rzeszów University of Technology, al. Powstanców Warszawy 6, 35-959 Rzeszów, Poland

² Institute of Agrophysics, Polish Academy of Sciences, Doświadczalna 4, 20-290 Lublin, Poland

³ TEREZ Performance Polymers Sp. z o.o. Rogoźnica 304, 36-060 Głogów Małopolski, Poland

* Corresponding author's email: ichmch@prz.edu.pl

ABSTRACT

Recent findings on some unsolved powder rheology problems and new challenges regarding mechanochemical powder processing and flow modelling are presented. There is remarkable difference in rheology when processing moist powders in static or dynamic conditions. Despite of regular trends of shear stress changes with humidity found in the both cases, some exceptions revealed the significant impact of particles size and their hygroscopic nature as example. Mechanochemical methods of high-energy interactive mixing of highly cohesive powders doped with nano-sized solid admixture enabled their flowability to be improved considerably. Using statistical approach, more general routine is proposed that allow the optimal mixing parameters to be reliably predicted with limited number of experiments needed. Ability to flow of some hygroscopic powders was examined with DEM method and extreme sensitivity of model output to input particle properties was found. The common DEM routine towards powder flow prediction is therefore suggested to be replaced with approach featuring in using DEM method to identify some unknown powder flow factors.

Keywords: powder flow, moisture content, mechanochemistry, DEM.

INTRODUCTION

In general, the key issues regarding powders are storage and flowability problems; further areas are pharmaceutical and food mixtures preparation, various materials composites formulation as well as particle design and energy storage enhancement. In this review these issues are addressed only in those aspects which are of technological significance. The authors' findings concerning these issues are discussed and referred to other published works within these fields.

Flow and storage problems are among the oldest questions concerning powder technology and irrespective of abundance of related literature, many of them have not yet been fully resolved. Powder flowability can be critically affected by

the presence of moisture, usually in the form of small amount of water existing between powder particles. The presence of water in some cases may be the result of manufacturing conditions, or more insidiously, it could be attributed to water vapor condensation from surrounding atmosphere. The latter case is rather unexpected and usually unpredictable and it may lead to substantial changes in the processing characteristics of powders and, in some extreme cases may be a reason to stop the process control [1, 2].

In the first part of the review, the rheology of moist powders of different nature (chemical, pharmaceutical, food, solid biomass and biomass-coal mixtures) as processed in static and dynamic conditions is discussed. The studies undertaken in static conditions are usually referred to storage of

powder in silos and the crucial question is how the process of silos discharging should be arranged. Dynamic conditions, on the other hand, are referred to processing of particulate solids in flow operations in various process industries where the fundamental issue is ability of powder to flow in a controlled and predictable manner. The variety of materials under investigation, wide range of their dimensions, physical and chemical properties and water content in experiments performed allowed the main factors influencing the powder rheology to be identified regarding specific group of powders, tests conditions, properties of solids, water content, powder blends proportion and others.

In the second part of the paper some new areas of powder exploration and the resulting challenges are presented. These include mechanochemical approach to powder particles physical modification and/or reactive alteration. Improved parameters of bulk operations and preparation of composite materials of strengthened physical or chemical properties are some of examples. The mechanical energy transitions of solids have a notable advantage since technologies realized mechanochemically do not require organic solvents and elevated pressure and temperature. Among the areas where mechanochemistry finds its successful practical implementation is also cohesive powder flowability improvement which is further discussed.

A relatively new mechanochemical approach to powder flow improvement is high-energy ordered mixing (HEM) (or interactive mixing) consisting in doping the agglomerated powder bed with small amount of finely comminuted, typically nano-sized additive and delivering to the bed some mechanical energy. This is typically accomplished using planetary ball mill/mixer (PBM) and the mixing in such environments is a multi-parametric process that demands optimization of the process parameters values. For that purpose design of experiment (DOE) technique and response surface methodology (RSM) were used. Following-up the optimization procedure the mixing parameters values can be found at which the powder flowability is significantly increased. This findings may be a basis for developing a general routine allowing the optimal parameter values of high-energy mixing in planetary ball mill to be credibly predicted regarding some physical properties of powders only with a limited number or no experiments needed. The successful use of such approach was demonstrated

in experiments carried out for Naproxen doped with nano-sized Aerosil additive.

In the third part of the paper powder flow modelling is discussed mainly in the context of the relevance of DEM method for powder flow prediction and common problems encountered using this method as well. The most often reported problems are high computational cost required for systems of large number of particles interacting in a powder bed and strong dependence of DEM response on employed contact model and particle properties as the inputs. The proposed solutions are generally of limited effectiveness and in authors' opinion the DEM is a valuable tool to examine particulate systems but still on a microscope scale, i.e. limited to the particle-particle or particle-wall interaction analysis instead of using it to powder mass flow predicting. Rather than try to transform the calculated microscopic parameters of individual particles, like velocities and positions into more or less reliable macroscopic behavior of the whole bed, it certainly seems possible to use the features of DEM method to verify some uncertain input data, e.g. particle properties values. This often applies when modelling the rheology of moist powders consisting of particles of hygroscopic properties, like in the case of many plant materials. The moisture can substantially change the properties of powder bed particles and this is often not accommodated during routine DEM calculations, except for a few examples [3, 4]. As a result the calculated data deviate substantially from those obtained experimentally and the level of the observed discrepancy could be a reliable measure of the rheological characteristics alteration due to moisture content in a powder bed.

POWDER FLOW PROBLEMS

Many attempts to study the rheological behavior of a cohesive powder have been undertaken and no general approach to flow improvement is given so far. A possible reason is a large number of factors influencing powder behavior. These include variety of existing methods to study ability to flow, different types of powders and their properties, as well as changeable surrounding conditions and different processing and storage parameters. An example of the diverse attitude to powder research may be a recent review on various methods of flowability

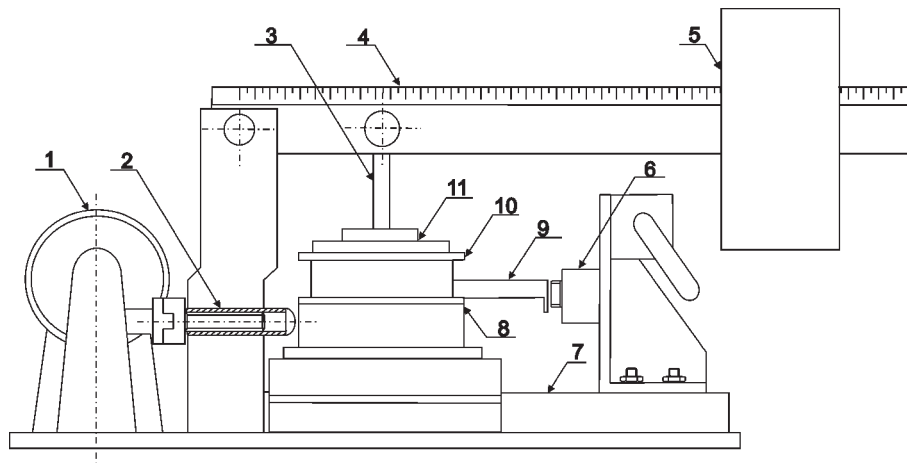

Fig. 1. Schematic representation of the Jenike-type shear tester. 1 – drive engine, 2 – drive pin; 3 – lever bar; 4 – lever; 5 – normal load; 6 –shear stress transducer; 7 – base; 8 – movable shear cell; 9 – arm of immovable shear cell; 10 – immovable shear cell; 11 – twisting cover

evaluation, as given by Ogata [5]. Hence, in this Chapter the factors influencing powder flow will be discussed separately in various categories of materials of different properties and economic use, like industrial goods, agricultural products and biomass energy-based resources.

Rheology of moist powders

The use of powders, irrespective of their nature, is commonly accompanied by moisture, usually water transferred from surrounding atmosphere to powder bed [1, 2]. The increase of water amount on particle surfaces gradually increases the particle contact area and causes the powder to become more cohesive. This, however is the case only for powders being in static conditions like those stored in silos.

Powder materials bed in motion may be in various rheological states. If the bed is subjected to low shear rates, its behavior cannot be described by the behavior of either liquid or solid. Such a state is referred to as the friction state or the Coulomb state [6]. In this state, the stress in material is created by friction of the particles in contact with each other. For high shear rates, individual particles have a sufficiently large energy reserve to allow the bed to behave in a way similar to a free-flowing liquid [7]. Static methods of testing powders provide information about their behavior under considerable external load and a negligible low deformation rate. Dynamic methods of testing powders provide information on their behavior under low external loads and high deformation rate.

In dynamic conditions, when powder is flowing under some external forces the increasing moisture content affects the flowability in the opposite way. These questions will be examined for all the three mentioned groups of powders and some new methods of flow improvements will be given.

Rheology in static conditions

An indication of potential powder flow properties in static (quasi static condition) is powder yield strength which was measured with Jenike-type shear-tester fabricated and used in accordance with the CEN Eurocode 1, 2006 procedure [8]. The schematic of the apparatus is shown in Fig. 1. The dimensions, operating principle and experimental protocol of the experiments

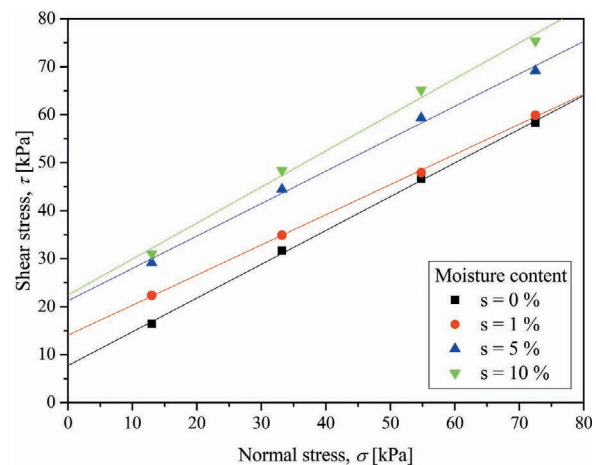

Fig. 2. The effect of moisture content on yield loci for limestone (36÷100 μm), $\sigma_n = 80.3$ kPa

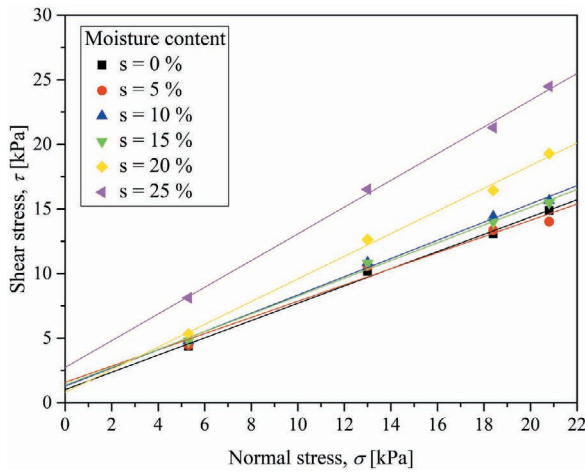

Fig. 3. The effect of moisture content on yield loci for semolina (100÷250 μm), $\sigma_n = 80.3$ kPa

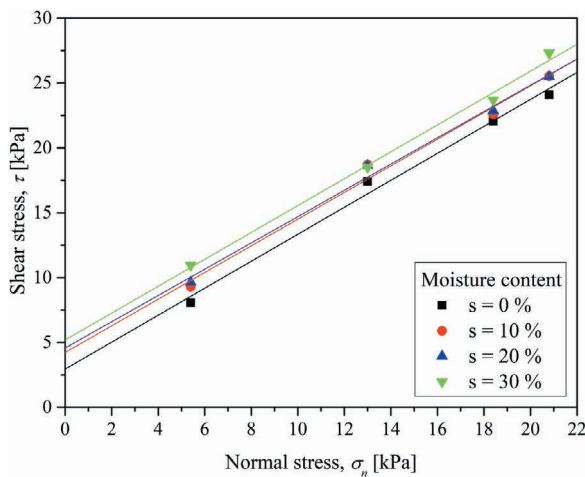

Fig. 4. The effect of moisture content on yield loci for beechwood sawdust (135-780 μm), $\sigma_n = 22.2$ kPa

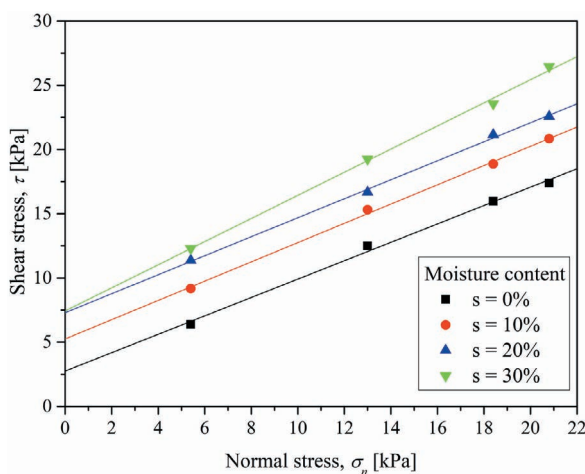

Fig. 5. The effect of moisture content on yield loci for hard coal (3-85 μm), $\sigma_n = 22.2$ kPa

performed with this equipment are given in earlier paper of the authors [9, 10].

With increasing moisture content, growing shear stresses in the bed were developed and mechanical strength of the moist bed was built involving resistance to flow to be larger. Measurements of shear strength were carried out using a consolidating stress value such that the material is sufficiently compacted. Some typical examples of this effect for selected materials from all these groups are shown in Figs. 2 to 5.

Similar results [11, 12] were obtained for other tested materials, like microcrystalline cellulose (Avicel 50 - 150 μm), silica gel (40 - 63 μm), PVC (150 - 250 μm), glass beads (250 - 500 μm), modified limestone (36 - 100 μm), powder paint (50 - 250 μm), amaranth (750 - 2000 μm), mustard (1000 - 3000 μm), millet grains (1000 - 2500 μm), wheat flour (36 - 150 μm), corn starch (50 - 200 μm), potato flour (36 - 750 μm), milk powder (75 - 250 μm), pine- (10 - 550 μm), oak- (170 - 720 μm), and cherry- (85 - 580 μm) sawdusts, sawdust mix (60 - 530 μm), MDF sawdust (45 - 725 μm), sunflower shells (180 - 800 μm), apple pomace (250 - 2000 μm), DDGS (Distillers Dried Grains with Solubles, 5 - 600 μm), meat and bone meal (150 - 2000 μm), hard coal (3 - 85 μm) and brown coal (10 - 115 μm). In all mentioned figures the moisture content s is defined as the ratio of water mass m_w and dry powder mass m_p as follows:

$$s = \frac{m_w}{m_p} \cdot 100\% \quad (1)$$

Rheology in dynamic conditions

Rheological characteristics of powders in dynamic conditions can be tested using a powder rheometer. There are few types of this relatively new equipment featuring of some innovative qualities. One of them is FT4 powder rheometer [13÷16]. It was applied to evaluate the powder flowability based on the total energy input which is related to the shear stress developed on the rheometer impeller blade. This construction is widely used to determine flow properties of industrial powders [17, 18], pharmaceutical solid dosage forms [19, 20] and also lignite [21]. New approach to determine powder flow is Anton Paar two cells powder rheometer with powder shear cell and powder flow cell [22]. The powder shear cell with temperature and humidity control is used to determine the flow characteristics of consolidated powders and their time-dependent behavior. The powder flow cell is an innovative

approach towards powder characterization in dynamic condition. The dynamic properties of powders can be also examined with a rotating drum tester – Granudrum powder rheometer [23]. This construction is used to study the dynamic flow properties of powders such as dynamic angle of repose and dynamic cohesivity index. The flowability of powder measured as a function of the shearing rates of the cell (rotating speed) allows for evaluating rheological properties such as shear thinning or shear thickening.

In this work an annular shear cell-type powder rheometer was used [24] and a simplified draft of this apparatus is given in Fig. 6. The design of the rheometer was based on that proposed earlier by Klausner et al. [25]. The construction details and operating principle were given elsewhere [24, 26] and here only the most important features of the apparatus are given.

A unique quality of this rheometer is that the level of shearing is confined to the thickness of shearing band of powder bed alone, and this is

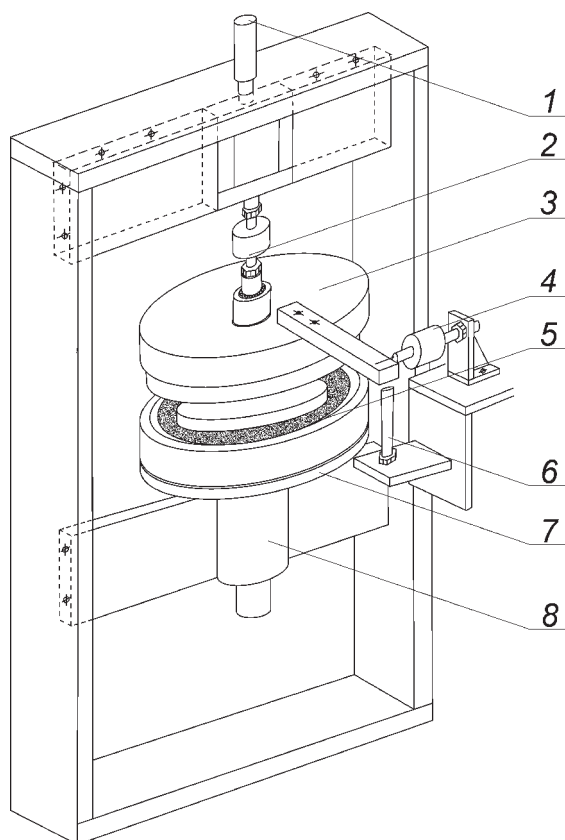

Fig. 6. Sketch of the annular powder rheometer: 1 – shear plate positioner, 2 – normal load transducer, 3 – shear plate, 4 – tangential load transducer, 5 – annular gap, 6 – displacement transducer, 7 – rotating cell, 8 – driving gear

usually not more than 15-20 particle diameters [25]. Thus, the real conditions of powder bed shearing are met, i.e. the shear stresses are measured for the particles moving in a shear band, rather than over the whole bed. Hence the data obtained in experiments can be reliably compared with those calculated theoretically.

The shear stresses measured with the rheometer, i.e. under low normal loads, changed with moisture content in an opposite way as compared to those measured with Jenike tester under high loads in static conditions [12]. With increased moisture content, the flow properties of majority of the tested powders and granular materials were clearly and regularly getting better as seen in Figs. 7 to 10.

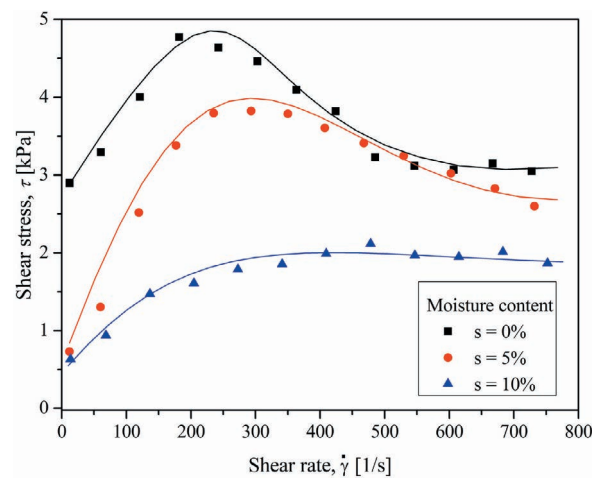

Fig. 7. The influence of moisture content and shear rate $\dot{\gamma}$ on shear stress τ for PVC powder (75 - 150 μm)

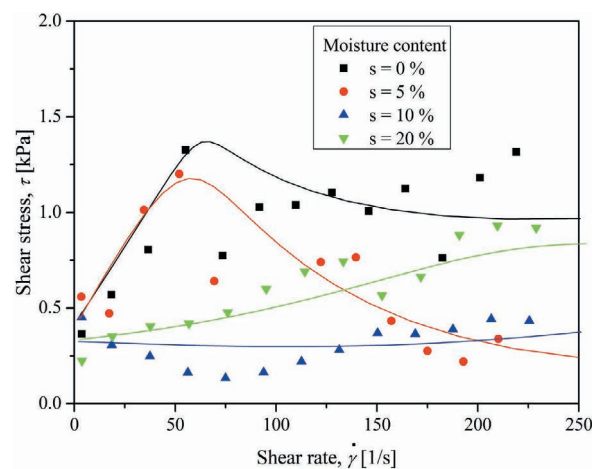

Fig. 8. The influence of moisture content and shear rate $\dot{\gamma}$ on shear stress τ for semolina (100 - 250 μm)

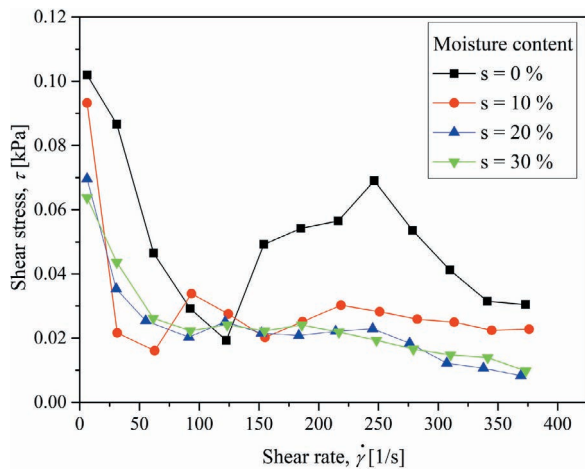

Fig. 9. The influence of moisture content and shear rate $\dot{\gamma}$ on shear stress τ for sawdust mixture: pine sawdust 60%, beech sawdust 20%, oak sawdust 10%, sycamore sawdust 10% (60 - 530 μm)

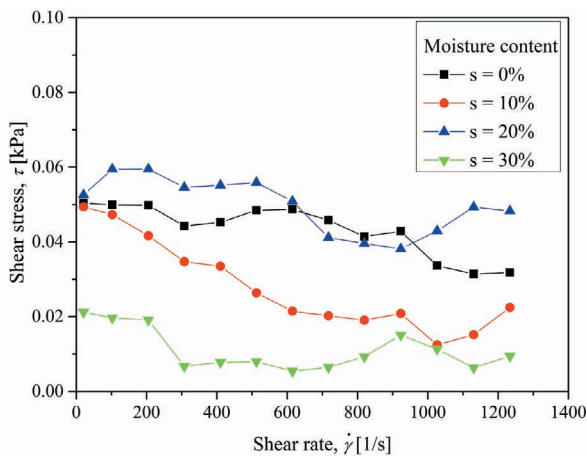

Fig. 10. The influence of moisture content and shear rate $\dot{\gamma}$ on shear stress τ for hard coal (3 - 85 μm)

Regardless of regularity in powder rheological characteristics as shown above, there were also some exemptions in terms of moisture content affecting powder rheology. This usually concerned fine powders and/or particles of hygroscopic nature. An example is limestone powder (particle diameter 36-100 μm). Rheological characteristics of the limestone without any surface modification is shown in Fig. 11, and after modification with a SARSIL (silicone impregnate to prevent water absorption) as surfactant – in Fig. 12.

Unexpectedly, the moisture affected the rheology of unmodified limestone powder unfavorably, i.e. in the opposite way as it was for other industrial materials. Under the surfactant influence,

the behavior of modified limestone powder was turned towards a typical rheological pattern.

A possible explanation of this effect may be given on the basis of specific surface properties of the limestone used and some experimental data on this may be found in paper by Vogt and Opaliński [27]. In more general terms it may be referred to the observed diversity in rheological characteristics obtained under high or low normal load, i.e. static or dynamic conditions. In static conditions (with Jenike’s shear tester) the powder bed is under high external normal load and the stresses developed in the bed are overwhelming and suppressing any other particle interactions (thus no difference in rheology of unmodified and modified limestone was observed). When the bed

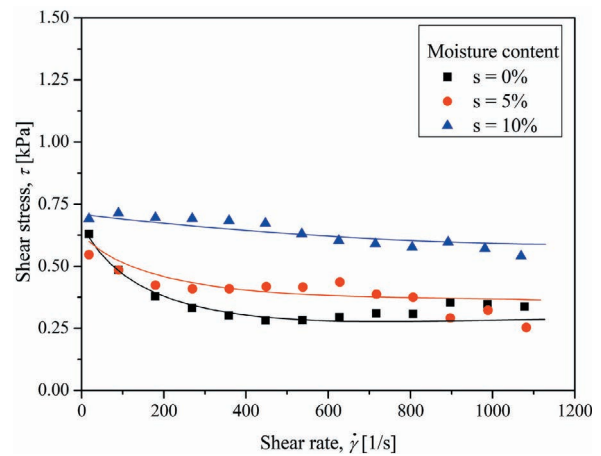

Fig. 11. The effect of moisture content and shear rate $\dot{\gamma}$ on shear stress τ for unmodified limestone (36 - 100 μm)

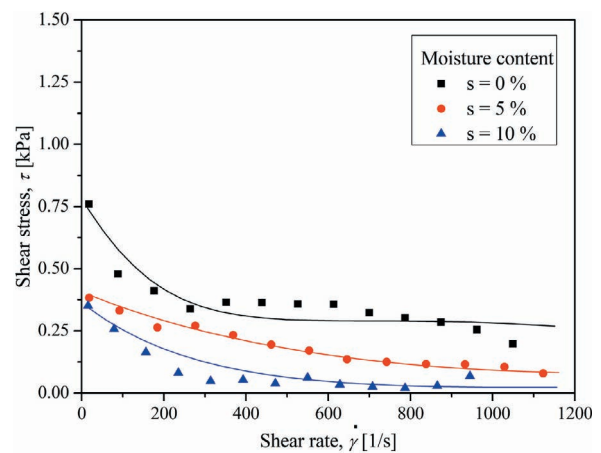

Fig. 12. The effect of moisture content and shear rate $\dot{\gamma}$ on shear stress τ for limestone (36 - 100 μm) modified with SARSIL

is in dynamic conditions (examined with powder rheometer), the stresses developed from low normal loads are small. As a results some weaker interparticle interactions can be exposed, as seen in the case of surface modification of limestone particles (a lubricating effect is possible to appear due to presence of surfactant).

Similar rheological exception concerning moist powders sheared in dynamic conditions (using powder rheometer) has been observed in the case of potato starch – Fig. 13. As opposed to other materials, both of these used in process industries and in agriculture, the effect of water content proved to be obviously unfavorable. Other examples of such rheological exemptions (tough not always as obvious) are milk powder and wheat flour [24].

It is believed that this reverse moisture impact on powder rheology may be a result of hygroscopic nature of materials. The fine, hygroscopic particles of potato starch or milk powder absorbed moisture into their grain cells thus preventing the water film between particles to be formed and lubrication effect to be developed as it was found for majority of the materials investigated (see Figs. 7 to 10 and 12). Another effect of water absorption by biomass particles may be that moist biomass particles become soft and swollen. As a result particle contact resistance increases and the powder flow is transformed from the stream of freely moving particles to slow, frictional flow of powder bed of larger mechanical strength.

A separate part of the performed research was related to biomass solids due to growing interest in the sustainable and increased use of renewable

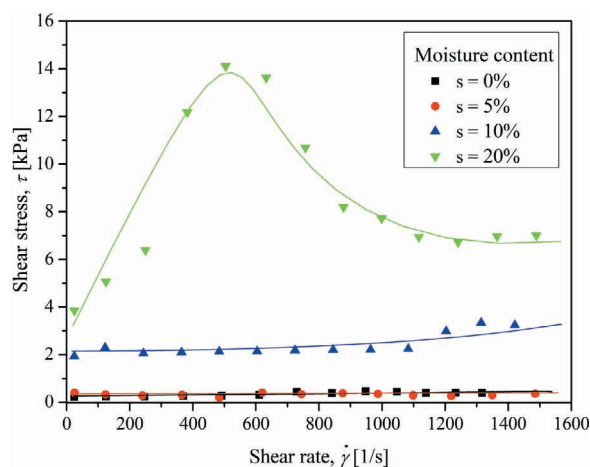

Fig. 13. The influence of moisture content and shear rate $\dot{\gamma}$ on shear stress τ for potato starch (36 - 750 μm)

energy sources. One of the primary troubles found when using powdered solid biomass is a negative impact of moisture content on physical properties of biomass grains [28]. The other concern is unsatisfactory flowability of biomass as compared to conventional solid fuels (e.g. granular or fine coal). A possible way to improve the bio-fuel flowability is to use the comminuted biomass in a mixture with coal [29].

As it is emphasized in the literature [30], the satisfactory flowability of the mixture is the key factor determining the efficiency of co-combustion processes.

On the basis of performed experiments using Jenike shear tester (static conditions) or powder rheometer (dynamic ones) it was found that rheological characteristics of moist biomass samples was equally advantageous as it was for industrial powders and that the moisture impact was particularly effective when moisture content exceeded rather high values - above 20% [31].

It was also found that rheology of biomass sample mixed with hard coal was better than it was for the components examined separately. This effect can be explained on the example of sawdust as solid biomass blended with hard coal as a conventional fuel. The main component of the solid biomass used was pine sawdust (60%). Remaining components were beech-, oak- and sycamore sawdust. This biomass composition will be further referred to as industrial sawdust mixture. The effect of water content on shear stress for hard coal is shown in Fig. 5 and for industrial sawdust

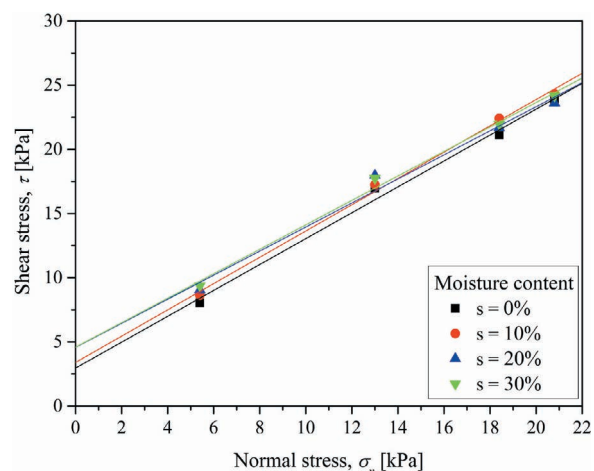

Fig. 14. The effect of moisture content on yield loci for industrial sawdust mixture: pine sawdust 60%, beech sawdust 20%, oak sawdust 10%, sycamore sawdust 10% (60 - 530 μm) $\sigma_n = 22.2$ kPa

mixture in Fig. 14. By comparing the data given in the Fig. 5 and in Fig. 14 it is clearly visible that dry coal has a good flowability, while wet coal flows badly, much worse than biomass, not only dry, but also moist. The high concentration of the yield loci lines for the sawdust mixture shown in Fig. 14 means that the moisture content has less influence on the mechanical strength of the biomass bed and this biomass property can be used to improve its flowability and, in the end-use, its co-combustion conditions with coal.

If the admixture of sawdust to coal is small, e.g. 5%, the mixture characteristics are unfavorable and deviate to a small extent from the flow

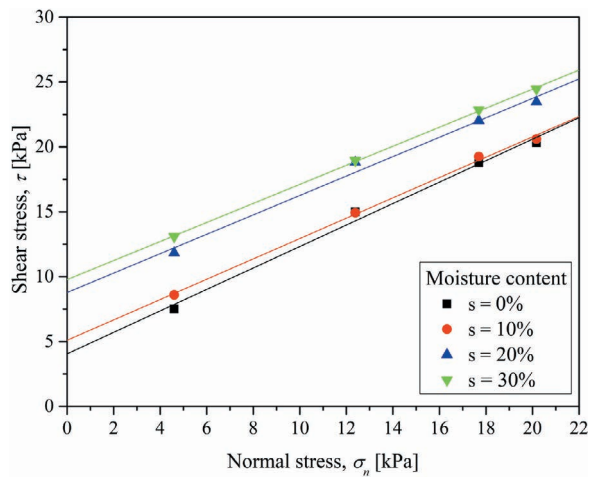

Fig. 15. The effect of moisture content on yield loci for mixture of sawdust (5 mass. %) and hard coal (95 mass. %)

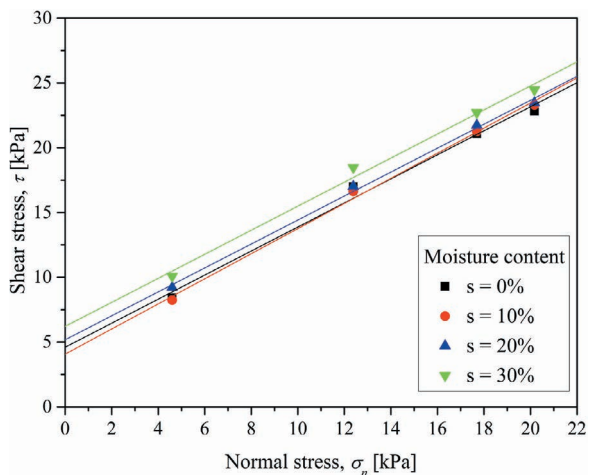

Fig. 16. The effect of moisture content on yield loci for mixture of sawdust (60 mass. %) and hard coal (40 mass. %)

characteristics of coal - Fig. 15. Increasing the content of biomass in the mixture reduces the adverse effect of moisture on the strength of the mixture and improves its flowability - Fig. 16. Similar results [12] were obtained for other tested mixtures, like DDGS and meat and bone meal mixtures with hard coal.

This positive impact of biomass with coal mixing may be related to water absorption by biomass particles. As the water amount in the mixture is lessening, the unfavorable effect of moisture content on rheology of moist hard coal is weakened (see Fig. 5), so the mixture flow is better. This leads to an interesting conclusion about the stabilizing effect of biomass on the mechanical properties of its mixtures with coal.

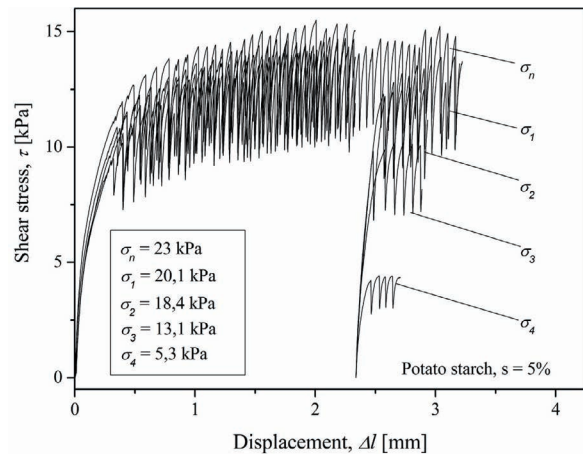

Fig. 17. Shear stress-displacement relationship for potato starch; water content $s = 5\%$, $\sigma_n = 23$ kPa

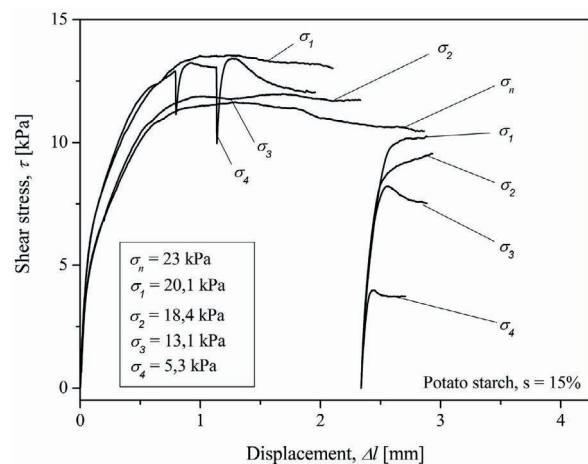

Fig. 18. Shear stress-displacement relationship for potato starch; water content $s = 15\%$, $\sigma_n = 23$ kPa

Therefore, the operations accompanying the process of biomass and coal co-firing can be carried out more safely and within wider range of humidity (difficult to control) values. This may be of significant importance for biomass logistics and also for handling and other operations concerning the mixtures being delivered to boilers or burners.

Flow singularities

In the context of the discussed regularities regarding the effect of moisture content on powder rheological characteristics, there are some interesting flow singularities. One of them involves shear stress oscillations clearly revealing in dry powder during shearing. The oscillation weakens when the powder is moistened and finally disappears at higher moisture content. This is shown in Figs. 17 and 18 for potato starch [7, 11].

The oscillations seen in Fig. 17 mean that across a small distance of the powder bed there are large variations in the shear strength. The oscillations may result in silo walls vibrations (“silo music”) as well as in a local increase of the bed density and its strength. Both of these factors are risky for storage equipment construction and hazardous for operating staff and environment. Some reasons for oscillation development in sheared powder bed are given elsewhere [7].

Other powder rheological oddness identified when powder was sheared in static conditions, is appearance of “lubricating point”, i.e. the moisture content value at which the influence of moisture content on rheological characteristics of powder bed becomes reversed [7, 10–12]. This took place usually at higher moisture content (above 10%)

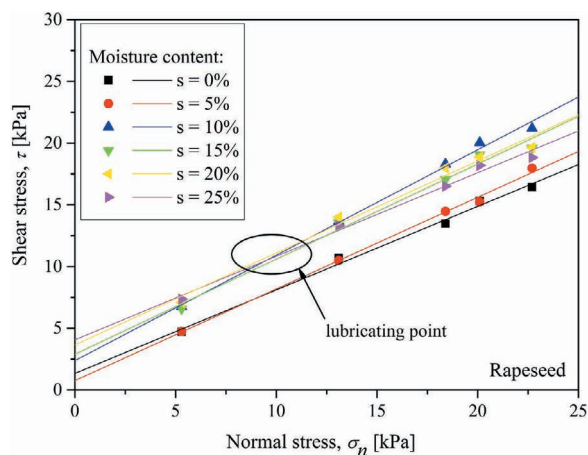

Fig. 19. The effect of moisture content on yield loci for rapeseed; $\sigma_n = 23$ kPa

and it was observed for some materials of all the three groups, e.g. glass beads, rapeseed, DDGS with brown coal mixture and others. Particularly clearly it was noticed for rapeseed and it is pictured in Fig. 19 [10].

An acceptable explanation of the lower values of shear stresses observed in the bed of rapeseed of larger water content is as follows: when moisture content becomes higher, some amount of free water appears in the bed as it cannot be absorbed by smooth and hard rapeseed surface any longer. The water layers lasting on the bed particles can in an obvious way result in particle surfaces lubrication and powder bed strength reduction.

Another interesting rheological feature related to some moistened powder samples tested in dynamic condition was “sharp flowability increase” caused by increasing moisture content at low values of shear rates. The essence of the event is presented in Fig. 20 and it is typical outcome for many studied mixtures of biomass with coal [12].

This may be related to a complex effect of frictional flow mechanism coupled with lubrication effect in slowly moving dense powder bed. From technological point of view this factor is of significant importance as it allows processes with powders to be economically realized.

IMPROVEMENT OF POWDER FLOWABILITY

Flowability, as a property of fine powders especially important in powder handling and processing,

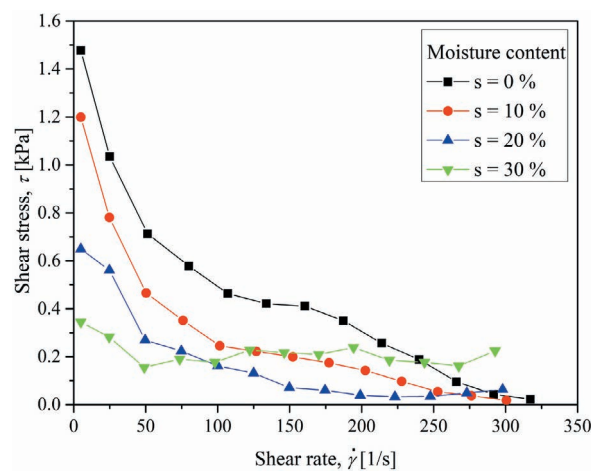

Fig. 20. The influence of moisture content on shear stress τ for the mixture: 60% of forest biomass and 40% of hard coal

is still investigated and improved. Many methods for powder flow improvement were used so far. Good examples are different methods of granulation applied in food, pharmaceutical or chemical industries [32–35]. Other methods toward enhancing powders flowability were mixing the powders with additives of various nature [36–40]. The mixing methods are particularly effective when using them in the form of mechanochemical technique of high-energy ordered mixing (or interactive mixing). The additives needed in the mixing process are most often inorganic oxides (e.g. fumed silica) and they are assigned to reduce the adhesive interactions between particles in the powder bed. Some salts of fatty acids (e.g., magnesium stearate) can be also applied as lubricants, being adsorbed on the surface of powder particles in the form of a monolayer. Due to additives cohesiveness and their tendency to agglomeration there is a problem to disperse them uniformly in the mixture during conventional blending. Hence high-energy mixing, called also dry coating or mechanofusion, has been employed as a more effective, environment-friendly and simpler method of improvement of powder ability to flow [41]. This relatively new mechanochemical approach consists in doping the agglomerated powder bed with small amount

of finely comminuted, typically nano-sized additive and delivering to the bed some mechanical energy. If the amount of energy is large enough, the agglomerates of both the bed and admixture particles are breaking apart. In the next stage the bed (host) particles are covered by admixture (guest) particles that makes van der Waals forces much weaker from those original ones previously existing in the agglomerated bed and flow properties of the resulting mixture improve [42, 43]. The effect of dry coating process is schematically presented in Fig. 21 and an example of surface changes after dry coating (obtained by the authors) is given in Fig. 22 (SEM images).

To perform the dry coating process, it is necessary to use some devices which are able to generate a great amount of mechanical energy, which is sufficient to break up the agglomerates of host and guest particles and to enable numerous collisions between them to exist. There are many methods and devices to perform high-energy interactive mixing and those especially advanced are manufactured in Japan, e.g. Mechanofusion by Hosokawa Micron, Hybrizider by Nara Machinery or Theta Composer by Tokujū Company. Background of dry coating as well as different methods and devices have been previously widely described in the literature, e. g. by [44, 45] and the reader is referred to this literature.

High-energy interactive mixing as a method of powder flowability improvement is mainly used for pharmaceutical powders. Over the last decade Zhou and co-workers extensively investigated the influence of dry particle coating on flowability of many pharmaceutical powders. One of the first works of this research team concerning mechanofusion was focused on the improvement of flowability of lactose monohydrate powder doped with small amount of fumed silica or magnesium stearate. For that purpose Nobilta mechanofusion system (Hosokawa Micron) and tumbling mixer [46] were applied. The results confirmed that mechanical dry particle coating is more efficient than traditional tumbling blending. In the subsequent works Zhou et al. proved that host particle size larger than 20 μm [47] and process conditions, providing greater amount of energy to the powder bed [48] have significant influence on surface modification and powder flow improvement. Moreover, it was found that the higher content of MgSt (up to a level of 5% w/w) on the bed particle surfaces, the stronger reduction of cohesive forces [49].

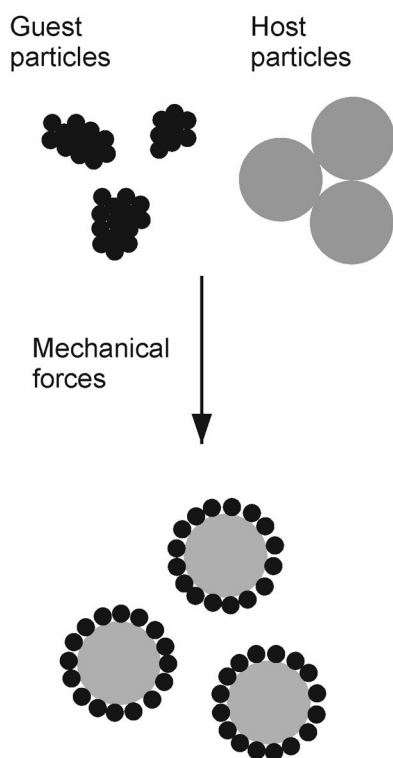

Fig. 21. Schematic representation of dry coating process

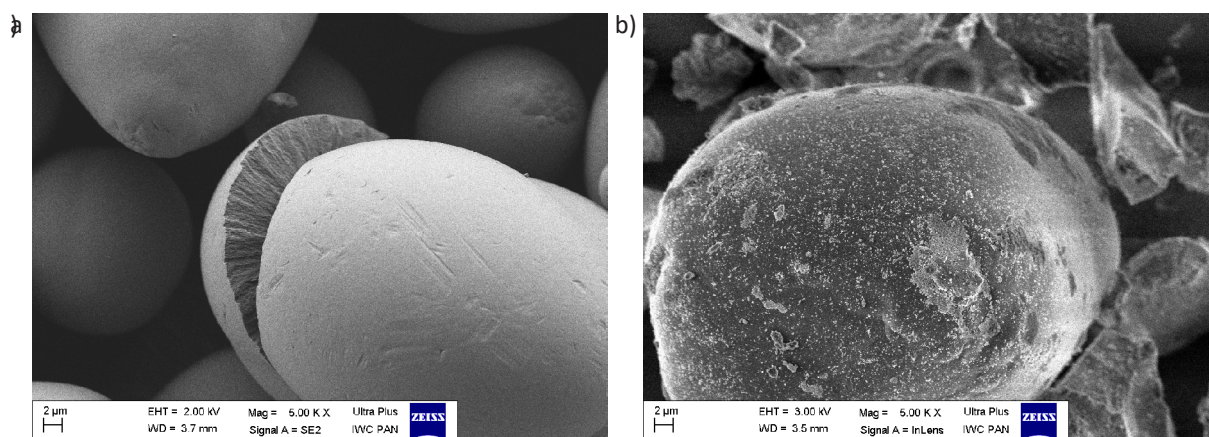

Fig. 22. Potato starch: a) before high-energy mixing, b) after high-energy mixing

The literature data indicate that the mechano-fusion also seems to be an effective method of improving aerosolization of API (e.g. salbutamol sulphate, salmeterol xinafoate, triamcinolone acetonide) and inactive additives (lactose) in dry powder inhalers systems as a result of cohesiveness reduction [50–52].

The effect of different guest particles (MgSt, silica, L-leucine, sodium stearate fumarate) on dissolution and flowability of fine ibuprofen powder has been examined by [53]. They demonstrated successful flowability enhancement in case of all investigated admixtures and showed that it depends mainly on surface coating effects instead of particle shape or size modification.

Active pharmaceutical powders were also dry coated using magnetic forces. Three API's with different shape and size: ibuprofen, acetaminophen and ascorbic acid were processed in magnetically assisted impaction coater (MAIC). Hydrophilic or hydrophobic nano-silica as invited particles were used in the work by Jallo et al. [54] and the authors managed to successfully transform even very cohesive powders to that of easy flowing.

To perform the dry coating process, some conventional pharmaceutical high-shear mixers or mills were also employed. Sato et al. [55] investigated how operation conditions in Cyclo-mix affect pharmaceutical excipients properties like Suglets during coating by MgSt. Regarding the flowability they showed that filling ratio was not important factor but longer processing time and higher rotating speed had significant influence on powder ability to flow. Mullarney et al. [56] successfully applied another high-shear mixer: conical screen mill (Comil), to

perform high-energy mixing in laboratory and pilot scale. They obtain dry coating effect as well as flowability enhancement by mixing excipients (mannitol, lactose monohydrate) and active ingredients like ibuprofen and another five APIs with silica. Huang et al. [57] confirmed application of Comil as a continuous-action device to improve pharmaceutical powders handling and processing. Han et al., [58, 59] obtained successful results in improving properties (e.g. flowability) of pharmaceutical blends using API (ibuprofen) after dry coating in Comil or dry coating and simultaneous micronization in fluid energy mill.

Pharmaceutical industry is not the only branch where problem of powder ability to flow is of such importance, but high energy-mixing in other branches is not as popular as it is in drug preparation. However, there are few works concerning powder flow enhancement via dry coating. For example, Ramlakhan et al. [60] applied dry coating in MAIC to improve handling of cornstarch powder and cellulose fibers using nano-silica as guest particles. Similarly they used nano-alumina powder as an additive to dry coat PMMA particles. Cohesive corn starch was also processed by Yang et al. [61] using MAIC and hybridizer. MAIC also turned out to be effective device to decrease cohesion between host aluminum particles via high-energy mixing with nanoparticles like silica, carbon black and titania [62]. Dry coating seems to be effective method of preparing polymers fillers, and calcium carbonate is an example. Simultaneously coating by silica and milling in fluid energy mill conducted by Qian et al. [63] reduced cohesion and increased flowability of CaCO_3 .

A promising device to perform high-energy mixing with the aim to ensure cohesive powders flowability improvement via dry coating is a planetary ball mill. For the first time it was proposed as a device to perform dry coating of powders by Sonoda et al. [64] to improve solubility of flurbiprofen powder in water. This type of mill consist of one or several grinding chambers attached to a rotating disc and filled with grinding balls. The large amount of mechanical energy which is needed to obtain dry coating effect is generated as a result of planet-like movement of the working chamber. This type of movement enforces the balls to move inside the chamber as well as provides the balls with large acceleration and frequent collisions.

The use of planetary ball mill for grinding or carrying out mechanochemical processes has been known for many years. However, until the 1990s, it was limited to laboratory purposes only. Furthermore, it was assumed that it is not possible to scale up the process. The problem of increasing the processed volumes of powders, as well as the continuous action of the planetary ball mill has been successfully solved over the past decades. Currently, this type of mill with a productivity of up to 5 t/h and continuous action are designed and manufactured mainly in Russia [65].

In the works by the authors a planetary ball mill was used for flowability improvement of cohesive powders, used mainly in chemical, pharmaceutical and food process industries: calcium carbonate [66], Apyral [67], Disulfiram (Esperal) [68] and potato starch [69] powders. The powders were doped with nano-sized silica (Aerosil) and also with propan-2-ol as a process control agent (PCA), needed to avoid caking of fine powders

during their mixing. To provide the right conditions for powder processing, an optimization of process parameters was accomplished. The optimal mixing parameters were specified using statistical procedures: response surface methodology and central composite rotatable design. Mathematical model equations describing the influence of input variables (mixing speed and time and the amount of additives used) on powder flowability indices (output variables) were based on the second order polynomial equation (Eq. 2) for coded levels of variables.

$$y = (b_0 + \varepsilon) + \sum_{i=1}^k b_i x_i + \sum_{1 \leq i < j}^k b_{ij} x_i x_j + \sum_{i=1}^k b_{ii} x_{ii}^2 \quad (2)$$

In the model above y is a flowability index (angle of repose or compressibility index), b_0 – constant term, ε – residual associated with the experiments, x – process variable and k – number of process factors. The results were presented on 3D response surface plots (converted to actual levels of variables) as it is shown in Figure 23.

The response surface methodology as illustrated above was successfully applied for all the aforementioned powders, however the full statistical procedure and results obtained for Disulfiram are not given here since they are intended for separate publication in the near future.

Model optimization of multi-parametric process, as is the case with interactive mixing, is difficult to formulate due to several local minima [66, 67, 69]. For that reason, to perform the process optimization, the authors’ suggestion is to convert the model equations to a desirability function. The specific feature of the function is that its maximum can be attributed to the best powder

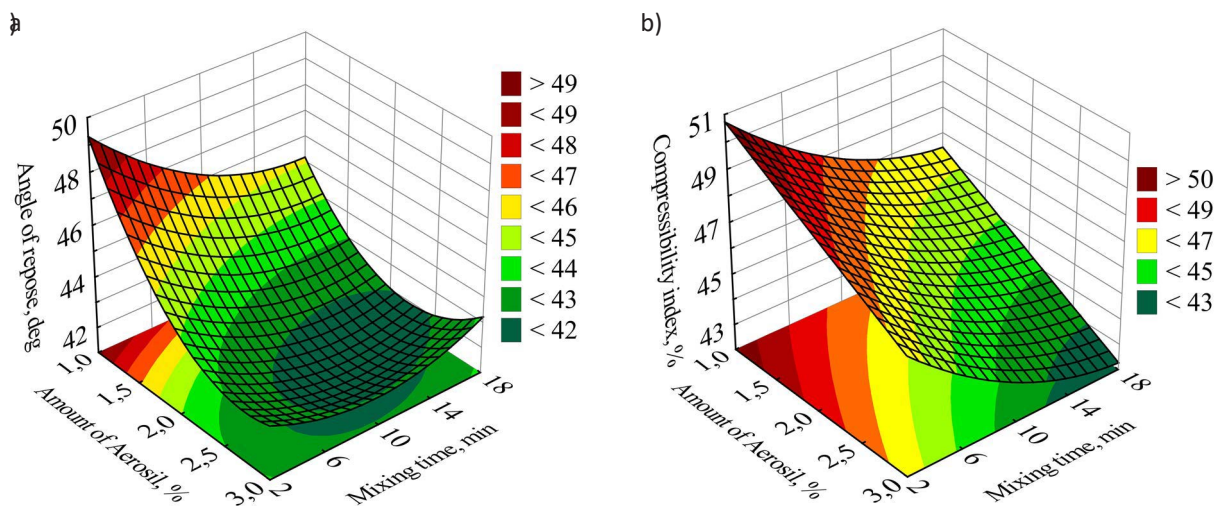

Fig. 23. 3D surface plots obtained for calcium carbonate properties: a) angle of repose, b) compressibility index

flowability, i.e. the smallest values of flowability indices (angle of repose and compressibility index). Following-up the optimization procedure the mixing parameters values and the amounts of applied additives are found at which the powder flowability was significantly better as it was originally. This findings may be a basis for developing a general routine allowing the optimal parameter values of high-energy mixing in planetary ball mill to be successfully predicted regarding some physical properties of powders only with a limited number or no experiments needed. The accuracy and reliability of the proposed procedure were successfully verified in experiments carried out for Naproxen doped with nano-sized Aerosil additive (to be published).

POWDER FLOW MODELLING

In the recent years the Discrete Element Method (DEM), resumed by Cundall and Strack [70], has become the most attractive and preeminent numerical technique to perform modelling of powder flow and designing of powder handling processes by taking advantage of significant computer hardware and computing capability development. Following the Lagrangian principles, the DEM allows tracking of each entity within a powder bed and predict macroscopic powder flow behavior as a result of microscopic activity of the individual particles in an assembly. Alternatively, continuum based methods such as the finite element method (FEM) are also applied but may fail to model such artefacts as large deformations or segregation associated with granular materials [71]. The DEM algorithm makes use of Newton's second law of translational and rotational motion to determine powder bed changes basing on the forces acting on each particle (or granular media entity) in the contact points between them. The contact model describing particle-particle and particle-geometry interaction determines the modelling process, hence its selection is crucial in the correct real systems representation. According to the contact models available in literature, the contact forces are functions of particles' overlap distance and other micro level parameters: particle size and shape, particle density, particle contact stiffness, contact damping and friction coefficients. Further model improvements may involve additional attractive and repulsive interactions (i.e. those caused by interstitial liquid or electrostatic charges). This method is

effective in modelling of dense systems and referred to as the soft-sphere approach in contrast to the hard-sphere approach more applicable in sparse dynamic systems [72, 73].

Since there is no generalized theory on granular materials which reliably predicts their behavior, numerical simulations can be used to predict and to optimize the processes in powder technology prior to industrial implementation. Fundamental advantage of the DEM is that it provides insight into the mechanisms governing particles flow in a variety of powder handling processes and is a powerful tool that enables recording of any required parameter also those difficult or impossible to measure in laboratory conditions. As a result DEM facilitates understanding granular dynamics and development of generalized rheological models [74, 75].

However, the computational requirement of DEM simulations for predicting real scale bulk flow resulting from contact detection and implicit integration problems is the main constraint inhibiting DEM analyses with numerous sets of particles and realistic particle geometries. Thus, despite introduction of dedicated computer hardware architecture based on multiplication of processor cores and parallelization of DEM code procedures by using subdomains or clusters [76] the DEM analyses are still limited to simplified cases (systems) or the micro level particle-particle or particle-wall interaction analysis. Another important constraint in effective DEM application is selecting appropriate input parameters so that simulations can accurately reproduce the behavior of real systems. Therefore a robust calibration procedure is indispensable prior to the simulation for real application purposes. Although the calibration process is a crucial step of every correct simulation, it is also a factor extending the time required to obtain a valuable prediction.

Direct and indirect methods are available in literature for DEM model calibration [71]. In the first approach, the particle properties are measured by experiments and then directly used as simulation input parameters. In indirect calibration, a bulk property (or performance) is registered, and then a set of simulation parameters is adjusted until the measured bulk properties match the desired real response of the studied system. Since the micro level properties are hard to measure, and frequently are not adequate when applied on a bulk level, the indirect procedures are dominant and referred to as the inverse calibration methods [71, 77].

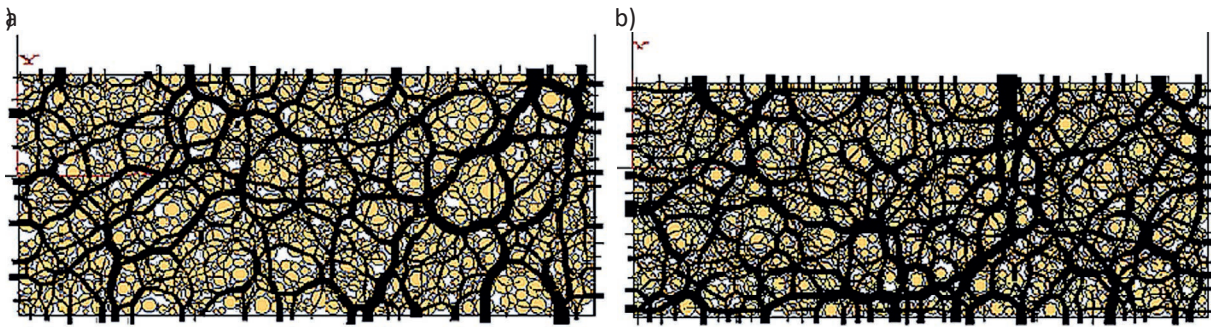

Fig. 24. Distribution of compressive stress as obtained by DEM for the case of dry DDGS (a), during Jenike cell test, and with 30% moisture content (b). The thicker the black lines in the figure, the higher the stress values; (from [12])

The calibration procedure was found necessary in the recent research regarding powder shear flow modelling using DEM. For example, Simons et al. [78] recognized Young’s modulus, the static, and the rolling friction coefficients as the most influential particle parameters in the observed tangential shear stress at steady state flow in the performed sensitivity analysis using the Schulze ring shear tester. The critical role of the static and the rolling friction coefficients affecting powder shear resistance expressed as basic flowability energy (BFE) and specific energy (SE) was confirmed in [79] and [80] during DEM calibration procedure for Freeman FT4 rheometer since it has become as a widely used technique for characterizing particle flow. The impact of inter-particle static and rolling friction coefficients and the resulting requirement for proper calibration of these parameters in the DEM simulation was shown also in other experiments involving powder shear flow including e.g. silo discharge [81], oedometric compression tests [82] or uniaxial compression tests [83].

The well-known effect of moisture content on bulk powder rheology via capillary cohesion forces was described and introduced to the classical $\mu(I)$ rheology [75], however only for materials resistant to water sorption and internal diffusion. The problem of hygroscopic materials of biological origin and alteration of their properties along with moisture was studied in [12]. At low level of water content these materials tend to absorb water and swell up to the point of saturation. Only exceeding the saturation point means starting the interstitial water adsorption process and formation of liquid bridges. For explanation of such phenomena on powder bed rheology below saturation point the swelling bed model

assuming linear effect of moisture content on the bio powder properties (particle density, volume and elasticity module) has been proposed and verified with DEM [12]. The increase of compressive stress obtained by DEM in the case of DDGS with 30% moisture content compared to dry DDGS material is shown in Fig. 24.

The results obtained in [24] for semolina of particle size (0.1-0.3 mm) support the idea that friction coefficients and damping factor of particulate materials are not constant and that they are significantly reduced at higher moisture content of the powder bed in the whole range of shear rates applied due to modification of outer particle surface properties (Fig. 25). The values of the friction coefficients as well as damping factor that had to be adjusted during the DEM simulations to

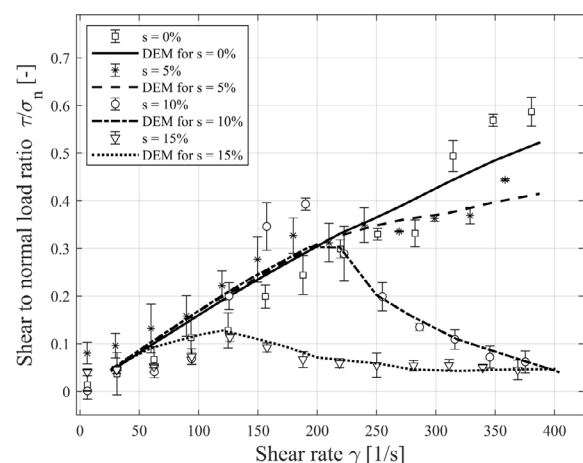

Fig. 25. The effect of moisture content s and shear rate $\dot{\gamma}$ on shear-to-normal stress ratio τ/σ_n for semolina (particle size 0.1–0.3 mm) (points), compared to DEM simulation results obtained after material surface properties calibration (lines); (from [24])

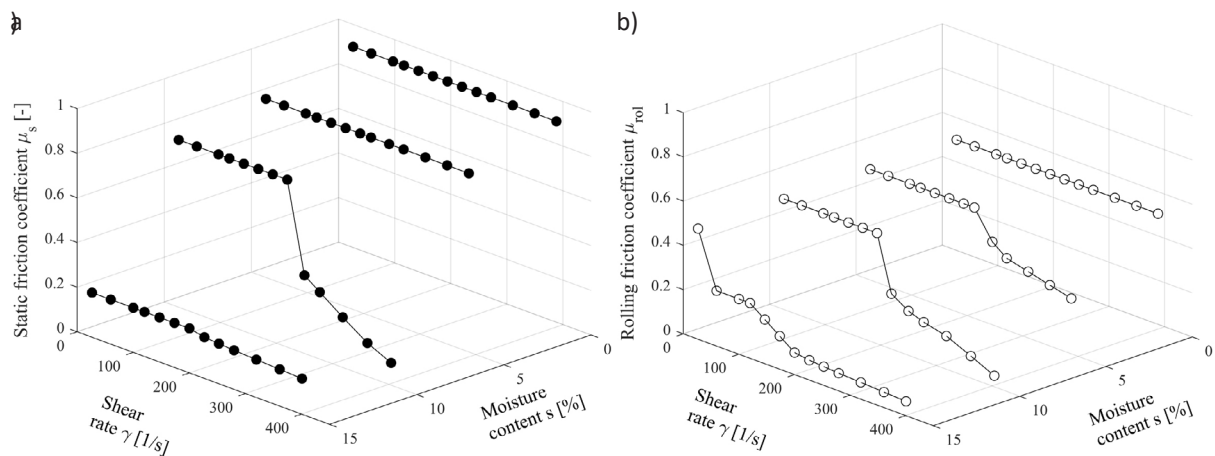

Fig. 26. Effects of shear rate and moisture content on: static (μ_s) friction coefficient (a), and rolling (μ_{rol}) friction coefficient (b) of semolina particles applied in DEM simulations of annular rheometer (from [24])

fit the experimental data can be treated as a quantitative measures of material's rheological properties. Sharp decrease of both friction coefficients for moist material (as shown in Fig. 26 for the semolina case) could be an indication of material surface properties modification followed by powder rheology changes, under assumption that the applied DEM contact model is correct.

The obtained results are a premise to continue the experimental verification and possibly generalization of rheology models based on DEM simulations in the range of high shear rates as well as for moist powder conditions. There are several necessary conditions for further progress. First is the increase of computing power of modern computers both by parallelization of multiple computing units particularly when the Moore's law of a doubling in processor performance every 18 months is no longer valid. In this regard application of the graphical processing units (GPUs) accelerating calculations, as shown in [84], and further optimization of DEM code may be of utmost importance. Secondly, the implementation of effective techniques for a DEM model calibration as well as for DEM code optimization. Among already confirmed procedures are Design of Simulation (DoS) techniques based on the idea of Design of Experiment (DoE) [80, 85, 86], artificial neural network (ANN) approach [77, 86], Bayesian filtering [82], or Young's modulus reduction [87]. Thirdly, focusing on hybrid continuum constitutive modelling (such as FEM) coupled with DEM approach to fully utilize the advantages of both ideas and to avoid or mitigate their respective drawbacks that has already resulted in promising results [88–90].

CONCLUSIONS

Rheology of moist powders is affected to the greatest extent by conditions the powders are operated. In static conditions that usually apply to powders storage, the increase in powder bed moisture definitely promotes the bed consolidation and obstructs the emptying of storage equipment. In dynamic conditions relevant to powder flow under low external forces, the moisture makes flow of many powders easier.

Exemptions from the trends specified above are likely to happen for powders composed of fine particles of hygroscopic nature and of modified surface properties and they were found in both static and dynamic conditions. In static ones these included development of shear stress oscillations in the bed with low or no water content as well as appearance of lubricating effect found for some smooth and hard (rapeseed) particle surfaces. On the other hand, in dynamic conditions it was observed that at low values of shear rates the flow increased sharply with moisture content increase and also that the rheological characteristics of moistened powders with modified surface properties was reversed.

Small amount of water content favorably affects the rheology of moist powders; damaging oscillations are markedly diminished or removed and the processes with powders handled under low external forces proceed smoothly.

Of the results obtained, those concerning biomass-coal mixtures are of practical meaning. Supplementing the moist bed of coal with solid biomass improves the mixture flowability and stabilizes its mechanical strength i.e. makes it more resistant to moisture content changes. Thus the

operations associated with biomass and coal co-firing can be carried out more safely and within wider range of unforeseeable humidity values.

Flow improvement still remains the challenge particularly with regard to nano-sized powdered materials which are of increasing importance to many branches of industry. A continued development of particle design approach and more progress and innovation with industrial-scale high-energy mixers operating possibly in a continuous mode seem to be the most recommendable lines of action for the future.

The obtained results are a premise to continue the experimental verification and possibly generalization of the way the DEM method is used to solve powder rheology problems. Further proceeding should cover a holistic approach including both techniques for calculations acceleration and also those numerical procedures, which coupled together allow to fully utilize their advantages and to avoid or mitigate their respective drawbacks.

Nomenclature

Symbol	Name	Unit
API	Active pharmaceutical ingredient	
ANN	Artificial neural network	
DEM	Discrete element method	
DoS	Design of simulation	
DoE	Design of experiment	
FEM	Finite element method	
GPU	Graphical processing units	
PMMA	Poly(methyl methacrylate)	
SEM	Scanning electron microscope	
b_0	constant term of polynomial equation Eq. 2	[-]
d_p	particle diameter	[mm]
l	inertial number	[-]
k	number of process factors in Eq. 2	[-]
p	pressure	[Pa]
s	moisture content in powder	[mass%]
x	process variable	[-]
$\dot{\gamma}$	shear rate	[1/s]
μ	apparent friction coefficient	[-]
μ_s	static friction coefficient	[-]
μ_{rol}	rolling friction coefficient	[-]
ϵ	residual associated with the experiments in Eq. 2	[-]
σ_n	normal stress	[Pa]
τ	shear stress	[Pa]
φ	internal angle of friction of a powder bed	[deg]

REFERENCES

1. Harnby N, Hawkins AE, Opalinski I. Measurement of the adhesional force between individual particles

with moisture present part 2: A novel measurement technique. Chem Eng Res Des. 1996.

2. Harnby N, Hawkins AE, Opalinski I. Measurement of the adhesional force between individual particles with moisture present part 1 : A review. Chem Eng Res Des. 1996.

3. Thakur SC, Ahmadian H, Sun J, Ooi JY. An experimental and numerical study of packing, compression, and caking behaviour of detergent powders. Particuology. 2014.

4. Sarnavi HJ, Noor Mohammadi A, Modares Motlagh A, Rahmani Didar A. Dem model of wheat grains in storage considering the effect of moisture content in direct shear test. Res J Appl Sci Eng Technol. 2013.

5. Ogata K. A review: Recent progress on evaluation of flowability and floodability of powder. KONA Powder and Particle Journal. 2019.

6. Tardos GI. A fluid mechanistic approach to slow, frictional flow of powders. Powder Technol. 1997;.

7. Opaliński I, Olechowski M, Chutkowski M. Effect of moisture on behaviour of powders. Part 2. Changes in rheological characteristics. Przem Chem. 2011;90/10:1886 – 1889.

8. CEN Eurocode 1. Eurocode 1 - Actions on structures - Part 4: Silos and tanks. Eurocode 1. 2006.

9. Opaliński I, Olechowski M, Chutkowski M. Effect of moisture on behaviour of powders. Part 1. Structural and strength alterations. Przem Chem. 2011;90/10:1882 – 1885.

10. Opaliński I, Chutkowski M, Stasiak M. Characterizing moist food-powder flowability using a Jenike shear-tester. J Food Eng. 2012;108(1).

11. Olechowski M. The influence of moisture on rheological properties of powders. 2012.

12. Przywara M. The influence of moisture and composition of biomass with coal mixtures on mechanical and rheological properties of solid biomass. 2014.

13. Forte G, Clark PJ, Yan Z, Stitt EH, Marigo M. Using a Freeman FT4 rheometer and Electrical Capacitance Tomography to assess powder blending. Powder Technol. 2018.

14. Freeman R. Measuring the flow properties of consolidated, conditioned and aerated powders - A comparative study using a powder rheometer and a rotational shear cell. Powder Technol. 2007.

15. Li M, Leturia M, Saleh K. Analysis of the periodic motion in a powder rheometer and development of a new flowability testing method. KONA Powder Part J. 2018.

16. Wang N, Lu H, Xu J, Guo X, Liu H. Velocity profiles of granular flows down an inclined channel. Int J Multiph Flow. 2019.

17. Leaper MC, Fisk E, Browne R. Feasibility study to investigate caking in washing powder formulations

- using a Freeman FT4 powder rheometer. Part Sci Technol. 2019.
18. Yun H, Dong L, Wang W, Bing Z, Xiangyun L. Study on the flowability of TC4 Alloy Powder for 3D Printing. In: IOP Conference Series: Materials Science and Engineering. 2018.
 19. Hertel M, Schwarz E, Kobler M, Hauptstein S, Steckel H, Scherließ R. Powder flow analysis: A simple method to indicate the ideal amount of lactose fines in dry powder inhaler formulations. Int J Pharm. 2018.
 20. Vivacqua V, López A, Hammond R, Ghadiri M. DEM analysis of the effect of particle shape, cohesion and strain rate on powder rheometry. Powder Technol. 2019.
 21. Jin Y, Lu HF, Guo XL, Gong X. The effect of water addition on the surface energy, bulk and flow properties of lignite. Fuel Process Technol. 2018.
 22. Lupo M, Schütz D, Riedl E, Barletta D, Poletto M. Assessment of a powder rheometer equipped with a cylindrical impeller for the measurement of powder flow properties at low consolidation. Powder Technol. 2019.
 23. Mohylyuk V, Styliari ID, Dmytryi N, Reiss P, Rajeev D. Assessment of the effect of Cellets' particle size on the flow in a Wurster fluid-bed coater via powder rheology. J Drug Deliv Sci Technol. 2019;54.
 24. Opaliński I, Chutkowski M, Hassanpour A. Rheology of moist food powders as affected by moisture content. Powder Technol. 2016;294:315–22.
 25. Klausner JF, Chen D, Mei R. Experimental investigation of cohesive powder rheology. In: Powder Technology. 2000.
 26. Opaliński I, Olechowski M, Chutkowski M. Effect of moisture on behaviour of powders. Part 2. Changes in rheological characteristics. Przem Chem. 2011;90(10).
 27. Vogt E, Opaliński I. The comparison of properties of hydrophobized limestone powders produced in different methods. In: Chemical Engineering Transactions. 2009.
 28. Zulfiqar M, Moghtaderi B, Wall TF. Flow properties of biomass and coal blends. Fuel Process Technol. 2006.
 29. Chen P, Yuan Z, Shen X, Zhang Y. Flow properties of three fuel powders. Particuology. 2012.
 30. Guo Q, Liu H, Chen X, Li S, Guo X, Gong X. Research on the flow properties of the blended particles of rice straw and coal. Fuel. 2012.
 31. Przywara M, Oliwa J, Opaliński I. Influence of moisture content on flowability of alternative solid biofuels. Part 2. Mixtures of biomass and coal. Inżynieria i Apar Chem. 2014;53:107–9.
 32. Macho O, Eckert M, Tomášová B, Peciar P, Ščasný M, Fekete R, et al. Modifying the properties of finely ground limestone by tumbling granulation. Sel Sci Pap - J Civ Eng. 2016.
 33. Ohsaki S, Nakahara Y, Nakamura H, Watano S. Flowability improvement of soft metal-organic framework particles by wet granulation. Microporous Mesoporous Mater. 2020.
 34. Schiano S, Chen L, Wu CY. The effect of dry granulation on flow behaviour of pharmaceutical powders during die filling. Powder Technol. 2018.
 35. Szulc K, Lenart A. Effect of agglomeration on flowability of baby food powders. J Food Sci. 2010.
 36. Etti CJ, Yusof YA, Chin NL, Mohd Tahir S. Effects of formulation on flowability of selected herbal powders using compendial methods and powder flow analyser. Int Food Res J. 2016.
 37. Lapierre-Boire LP, Blais C, Pelletier S, Chagnon F. Improvement of flow of an iron-copper-graphite powder mix through additions of nanoparticles. Powder Technol. 2016.
 38. Ma B, Jiang Q, Huang J, Wang X, Leng J. Effect of different silica particles on flowability of gypsum powder for 3D powder printing. Constr Build Mater. 2019.
 39. Morin G, Briens L. The effect of lubricants on powder flowability for pharmaceutical application. AAPS PharmSciTech. 2013.
 40. Stasiak M, Molenda M, Horabik J, Mueller P, Opaliński I. Mechanical properties of potato starch modified by moisture content and addition of lubricant. Int Agrophysics. 2014.
 41. Qu L, Zhou Q, Denman JA, Stewart PJ, Hapgood KP, Morton DAV. Influence of coating material on the flowability and dissolution of dry-coated fine ibuprofen powders. Eur J Pharm Sci. 2015.
 42. Alonso M, Alguacil FJ. Dry mixing and coating of powders. Rev Metal. 1999.
 43. Saharan V, Kukkar V, Kataria M, Kharb V, Choudhury P. Ordered mixing: mechanism, process and applications in pharmaceutical formulations. Asian J Pharm Sci. 2008.
 44. Pfeffer R, Dave RN, Wei D, Ramlakhan M. Synthesis of engineered particulates with tailored properties using dry particle coating. Powder Technol. 2001.
 45. Sharma R, Setia G. Mechanical dry particle coating on cohesive pharmaceutical powders for improving flowability - A review. Powder Technology. 2019.
 46. Zhou Q, Qu L, Larson I, Stewart PJ, Morton DAV. Improving aerosolization of drug powders by reducing powder intrinsic cohesion via a mechanical dry coating approach. Int J Pharm. 2010.
 47. Zhou Q, Armstrong B, Larson I, Stewart PJ, Morton DAV. Understanding the influence of powder flowability, fluidization and de-agglomeration characteristics on the aerosolization of pharmaceutical model powders. Eur J Pharm Sci. 2010.
 48. Zhou Q, Qu L, Larson I, Stewart PJ, Morton DAV. Effect of mechanical dry particle coating on the im-

- provement of powder flowability for lactose monohydrate: A model cohesive pharmaceutical powder. *Powder Technol.* 2011.
49. Zhou Q, Qu L, Gengenbach T, Denman JA, Larson I, Stewart PJ, et al. Investigation of the extent of surface coating via mechanofusion with varying additive levels and the influences on bulk powder flow properties. *Int J Pharm.* 2011.
 50. Zhou Q, Armstrong B, Larson I, Stewart PJ, Morton DAV. Improving powder flow properties of a cohesive lactose monohydrate powder by intensive mechanical dry coating. *J Pharm Sci.* 2010.
 51. Zhou Q, Armstrong B, Larson I, Stewart PJ, Morton DAV. Effect of host particle size on the modification of powder flow behaviours for lactose monohydrate following dry coating. In: *Dairy Science and Technology.* 2010.
 52. Zhou Q, Qu L, Gengenbach T, Larson I, Stewart PJ, Morton DAV. Effect of surface coating with magnesium stearate via mechanical dry powder coating approach on the aerosol performance of micronized drug powders from dry powder inhalers. *AAPS PharmSciTech.* 2013.
 53. Qu L, Morton D, Zhou Q. Particle Engineering Via Mechanical Dry Coating in the Design of Pharmaceutical Solid Dosage Forms. *Curr Pharm Des.* 2015.
 54. Jallo LJ, Ghoroi C, Gurumurthy L, Patel U, Davé RN. Improvement of flow and bulk density of pharmaceutical powders using surface modification. *Int J Pharm.* 2012.
 55. Sato A, Serris E, Grosseau P, Thomas G, Chamayou A, Galet L, et al. Effect of operating conditions on dry particle coating in a high shear mixer. *Powder Technol.* 2012.
 56. Mullarney MP, Beach LE, Davé RN, Langdon BA, Polizzi M, Blackwood DO. Applying dry powder coatings to pharmaceutical powders using a comil for improving powder flow and bulk density. *Powder Technol.* 2011.
 57. Huang Z, Scicolone J V., Gurumuthy L, Davé RN. Flow and bulk density enhancements of pharmaceutical powders using a conical screen mill: A continuous dry coating device. *Chem Eng Sci.* 2015.
 58. Han X, Ghoroi C, To D, Chen Y, Davé R. Simultaneous micronization and surface modification for improvement of flow and dissolution of drug particles. *Int J Pharm.* 2011.
 59. Han X, Ghoroi C, Davé R. Dry coating of micronized API powders for improved dissolution of directly compacted tablets with high drug loading. *Int J Pharm.* 2013.
 60. Ramlakhan M, Wu CY, Watano S, Dave RN, Pfeffer R. Dry particle coating using magnetically assisted impaction coating: Modification of surface properties and optimization of system and operating parameters. In: *Powder Technology.* 2000.
 61. Yang J, Sliva A, Banerjee A, Dave RN, Pfeffer R. Dry particle coating for improving the flowability of cohesive powders. *Powder Technol.* 2005.
 62. Jallo LJ, Schoenitz M, Dreizin EL, Dave RN, Johnson CE. The effect of surface modification of aluminum powder on its flowability, combustion and reactivity. *Powder Technol.* 2010.
 63. Qian Z, Wang P, Gogos CG. Modifying CaCO₃ fillers with nanoparticles using a fluid energy mill. In: *Annual Technical Conference - ANTEC, Conference Proceedings.* 2011.
 64. Sonoda R, Horibe M, Oshima T, Iwasaki T, Watano S. Improvement of dissolution property of poorly water-soluble drug by novel dry coating method using planetary ball mill. *Chem Pharm Bull.* 2008.
 65. Fokina EL, Budim NI, Kochnev VG, Chernik GG. Planetary mills of periodic and continuous action. In: *Journal of Materials Science.* 2004.
 66. Leś K, Kowalski K, Opaliński I. Optimisation of process parameters in high energy mixing as a method of cohesive powder flow ability improvement. *Chem Process Eng - Inz Chem i Proces.* 2015.
 67. Leś K, Opaliński I. Prospective Application of Response Surface Methodology for Predicting High-Energy Mixing Process Conditions towards Fine Powders Flow Improvement. *Adv Sci Technol Res J.* 2021.
 68. Opaliński I, Leś K, Kozdra S, Przywara M, Chauveau J, Bonnet A. Prospective Application of High Energy Mixing for Powder Flow Enhancement and Better Performance of Hydrogen and Energy Storage Systems. In: *Ochowiak M, Woziwodzki S, Doligalski M, Mitkowski P, editors. Practical Aspects of Chemical Engineering.* 2018. p. 349–61.
 69. Leś K, Kozdra S, Opaliński I. Optimization of flow indices by response surface methodology in high-energy mixing of powders. *Przem Chem.* 2017.
 70. Cundall PA, Strack ODL. A discrete numerical model for granular assemblies. *Geotechnique.* 1979.
 71. Coetzee CJ. Review: Calibration of the discrete element method. *Powder Technology.* 2017.
 72. Martín MM, Hassanpour A, Pasha M, Alizadeh Behjani M. Discrete Element Method Applications in Process Engineering. In: *Introduction to Software for Chemical Engineers.* 2019.
 73. Zhu HP, Zhou ZY, Yang RY, Yu AB. Discrete particle simulation of particulate systems: A review of major applications and findings. *Chemical Engineering Science.* 2008.
 74. Chialvo S, Sun J, Sundaresan S. Bridging the rheology of granular flows in three regimes. *Phys Rev E - Stat Nonlinear, Soft Matter Phys.* 2012.
 75. Roy S, Luding S, Weinhart T. A general(ized) local rheology for wet granular materials. *New J Phys.* 2017.

76. Pöschel T, Schwager T. Computational granular dynamics: Models and algorithms. *Computational Granular Dynamics: Models and Algorithms*. 2005.
77. Do HQ, Aragón AM, Schott DL. A calibration framework for discrete element model parameters using genetic algorithms. *Adv Powder Technol*. 2018.
78. Simons TAH, Weiler R, Strege S, Bensmann S, Schilling M, Kwade A. A ring shear tester as calibration experiment for DEM simulations in agitated mixers - A sensitivity study. In: *Procedia Engineering*. 2015.
79. Hare C, Zafar U, Ghadiri M, Freeman T, Clayton J, Murtagh MJ. Analysis of the dynamics of the FT4 powder rheometer. *Powder Technol*. 2015.
80. Wilkinson SK, Turnbull SA, Yan Z, Stitt EH, Marigo M. A parametric evaluation of powder flowability using a Freeman rheometer through statistical and sensitivity analysis: A discrete element method (DEM) study. *Comput Chem Eng*. 2017.
81. Coetzee CJ, Els DNJ. Calibration of discrete element parameters and the modelling of silo discharge and bucket filling. *Comput Electron Agric*. 2009.
82. Cheng H, Shuku T, Thoeni K, Tempone P, Luding S, Magnanimo V. An iterative Bayesian filtering framework for fast and automated calibration of DEM models. *Comput Methods Appl Mech Eng*. 2019.
83. Orefice L, Khinast JG. A novel framework for a rational, fully-automatised calibration routine for DEM models of cohesive powders. *Powder Technol*. 2020.
84. Desai PS, Mehta A, Dougherty PSM, Higgs FC. A rheometry based calibration of a first-order DEM model to generate virtual avatars of metal Additive Manufacturing (AM) powders. *Powder Technol*. 2019.
85. Pantaleev S, Yordanova S, Janda A, Marigo M, Ooi JY. An experimentally validated DEM study of powder mixing in a paddle blade mixer. *Powder Technol*. 2017.
86. Zhou H, Hu Z, Chen J, Lv X, Xie N. Calibration of DEM models for irregular particles based on experimental design method and bulk experiments. *Powder Technol*. 2018.
87. Lommen S, Schott D, Lodewijks G. DEM speedup: Stiffness effects on behavior of bulk material. *Particuology*. 2014.
88. Avci B, Wriggers P. A DEM-FEM coupling approach for the direct numerical simulation of 3D particulate flows. *J Appl Mech Trans ASME*. 2012.
89. Guo N, Zhao J. A coupled FEM/DEM approach for hierarchical multiscale modelling of granular media. *Int J Numer Methods Eng*. 2014.
90. Haddad H, Guessasma M, Fortin J. A DEM-FEM coupling based approach simulating thermomechanical behaviour of frictional bodies with interface layer. *Int J Solids Struct*. 2016.